

# PENTAX™

Digital Camera

## Optio E40

**Operating Manual**

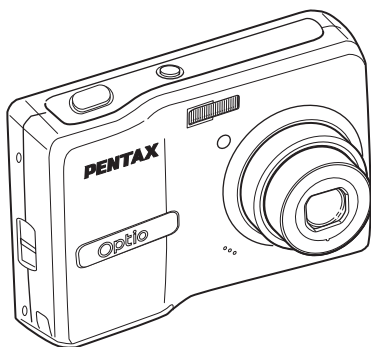

To ensure the best performance from your camera, please read the Operating Manual before using the camera.

Thank you for purchasing this PENTAX Digital Camera.

Please read this manual before using the camera in order to get the most out of all the features and functions. Keep this manual safe, as it can be a valuable tool in helping you to understand all the camera's capabilities.

### **Regarding copyrights**

Images taken using this PENTAX Digital Camera that are for anything other than personal enjoyment cannot be used without permission according to the rights as specified in the Copyright Act. Please take care, as there are even cases where limitations are placed on taking pictures even for personal enjoyment during demonstrations, performances or of items on display. Images taken with the purpose of obtaining copyrights also cannot be used outside the scope of use of the copyright as laid out in the Copyright Act, and care should be taken here also.

### **Regarding trademarks**

- PENTAX and Optio are trademarks of PENTAX Corporation.
-  SDHC logo is trademark.
- ImageLink and the ImageLink print system logo are trademarks of Eastman Kodak Company used under license.
- This product supports PRINT Image Matching III. PRINT Image Matching enabled digital still cameras, printers and software help photographers to produce images more faithful to their intentions. Some functions are not available on printers that are not PRINT Image Matching III compliant.

Copyright 2001 Seiko Epson Corporation. All Rights Reserved.

PRINT Image Matching is a trademark of Seiko Epson Corporation.

The PRINT Image Matching logo is a trademark of Seiko Epson Corporation.

- All other brands or product names are trademarks or registered trademarks of their respective companies.

### **To users of this camera**

- There is a possibility that recorded data may be erased or that the camera may not function correctly when used in surroundings such as installations generating strong electromagnetic radiation or magnetic fields.
- The liquid crystal panel used in the LCD display is manufactured using extremely high precision technology. Although the level of functioning pixels is 99.99% or better, you should be aware that 0.01% or fewer of the pixels may not illuminate or may illuminate when they should not. However, this has no effect on the recorded image.

### **Regarding PictBridge**

PictBridge allows the user to connect the printer and digital camera directly, using the unified standard for the direct printout of images. You can print images directly from the camera through a few simple operations.

#### **Regarding Product Registration**

In order to better serve you, we request that you complete the product registration, which can be found on the CD-ROM supplied with the camera or on the PENTAX website. Thank you for your cooperation.

Refer to the PC Connection Manual (bottom right on page 1) for more information.

There is a possibility that the illustrations and the display screen of the LCD monitor in this manual are different from the actual product.

## USING YOUR CAMERA SAFELY

We have paid close attention to the safety of this product. When using this product, we request your special attention regarding items marked with the following symbols.



### **Warning**

This symbol indicates that violating this item could cause serious personal injuries.



### **Caution**

This symbol indicates that violating this item could cause minor or medium personal injuries, or material losses.

## About the Camera



### **Warning**

- Do not attempt to take the camera apart or remodel the camera. High voltages are present within the camera, and there is therefore a danger of electric shocks if the camera is taken apart.
- If the inside of the camera should become exposed as a result of, for example, the camera being dropped, please do not under any circumstances touch such exposed portions, as there is a danger of receiving an electric shock.
- To avoid the risk of it being swallowed by mistake, keep the SD Memory Card out of the reach of small children. Seek medical attention immediately if a card is accidentally swallowed.
- Wrapping the strap of the camera around your neck is also dangerous. Please take care that small children do not hang the strap around their necks.
- Use an AC adapter that is of the power and voltage specified for exclusive use with this product. The use of an AC adapter other than that specified exclusively for use with this product may cause fire or electric shocks.
- If the camera emits smoke or a strange smell, or in the event of any other irregularity, stop using the camera immediately, remove the batteries or unplug the AC adapter, and contact your nearest PENTAX Service Center. Continued use of the camera may result in fire or electric shock.
- During thunderstorms, unplug and discontinue use of the AC adapter. Continued use could cause equipment failure, a fire, or electric shock.

## **Caution**

- Never try to disassemble or short the batteries. Also, do not dispose of the batteries in a fire, as they may explode.
- Do not charge any batteries other than rechargeable Ni-MH batteries. The batteries could explode or catch fire. Batteries for use with this camera other than Ni-MH batteries cannot be charged.
- Do not place your finger on the flash when it is discharging as there is a risk of burns.
- Do not discharge the flash while it is touching your clothing as there is a risk of discoloring of the clothing.
- If any of the battery leakage should come in contact with your eyes, do not rub them. Flush your eyes with clean water and get medical attention immediately.
- If any of the battery leakage should come in contact with skin or clothes, wash the affected areas thoroughly with water.
- Remove the batteries from the camera immediately if they become hot or emit smoke. Be careful not to burn yourself during removal.
- Some portions of the camera heat up during use, so please take care, as there is a risk of low temperature burns if such portions are held for long periods of time.
- Should the LCD be damaged, be careful of glass fragments. Also, be careful not to allow the liquid crystal to get on your skin or in your eyes or in your mouth.

## **Handling Precautions for Batteries**

- This camera uses two AA alkaline, AA lithium, AA Ni-MH or AA nickel manganese batteries. Do not use batteries other than those specified here. Using some other type of battery may cause the camera to function poorly, or the batteries may rupture or cause a fire.
- AA alkaline, AA lithium and AA nickel manganese batteries cannot be recharged. Do not try to take the batteries apart. The batteries may rupture or leak if you try to charge them or take them apart.
- Do not remove the external seal of the battery. If the seal is removed, the battery may short and may cause a fire, rupture, leak or heat.
- When replacing the batteries, do not combine different brands, types or capacities. Also, do not combine old batteries with new ones. Doing so may cause the batteries to rupture or cause a fire.
- Do not insert the batteries with the positive (+) and negative (–) poles in the wrong orientation. Doing so may cause the batteries to rupture or cause a fire.

## About the AC Adapter

### Caution

- Do not place heavy objects on the AC plug cord, allow heavy objects to drop onto it or allow the AC plug cord to become damaged due to excessive bending. If the AC plug cord becomes damaged, consult a PENTAX Service Center.
- Do not short or touch the output terminals of the product while it is still plugged in.
- Do not plug in the AC plug cord with wet hands. This can cause an electrical shock.
- Do not subject the product to strong impacts or allow it to drop onto a hard surface. This can cause a malfunction.
- To reduce the risk of hazards, use only CSA/UL Certified power supply cord set, cord is Type SPT-2 or heavier, minimum NO.18 AWG copper, one end with a molded-on male attachment plug cap (with a specified NEMA configuration), and the other is provided with a molded-on female connector body (with a specified IEC nonindustrial type configuration) or the equivalent.

## Care to be Taken During Handling

- Take the Worldwide Service Network listing that is included in the package with you when traveling. This will be useful if you experience problems abroad.
- When the camera has not been used for a long time, confirm that it is still working properly, particularly prior to taking important pictures (such as at a wedding or during traveling). Contents of the recording cannot be guaranteed if recording, playback or transferring your data to a computer, etc. is not possible due to a malfunction of your camera or recording media (SD Memory Card), etc.
- The lens on this camera is not interchangeable. The lens is not removable.
- Do not clean the product with organic solvents such as thinner, alcohol or benzene.
- Places of high temperature and humidity should be avoided. Particular care should be taken regarding vehicles, which can become very hot inside.
- Storing the camera where pesticides and chemicals are handled should be avoided. Remove from case and store in a well-ventilated place to prevent the camera from becoming moldy during storage.

- As this camera is not waterproof, do not use the camera where it may come in contact with rain, water or any other liquid.
- Ensure that the camera is not subjected to substantial vibrations, shock, or pressure. Use a cushion to protect the camera when it is subjected to the vibrations of a motorbike, car, ship, etc.
- The temperature range in which the camera can be used is 0°C to 40°C (32°F to 104°F).
- The LCD monitor will become black at a high temperature but will return to normal when normal temperatures are returned to.
- The response speed of the LCD monitor becomes slow at low temperatures. This is due to the properties of the liquid crystal and is not a fault.
- Periodic checks are recommended every 1 to 2 years in order to maintain high performance.
- If the camera is subjected to rapid temperature changes, condensation may form on the inside and outside of the camera. Therefore put the camera in a bag or plastic bag, and take the camera out when the difference in temperature has subsided.
- Be careful not to allow dirt, mud, sand, dust, water, toxic gases or salt to enter the camera as this may damage the camera. Wipe away any raindrops or water droplets and allow the camera to dry.
- Refer to "Precautions When Using an SD Memory Card" (p.24) regarding the SD Memory Card.
- Please note that formatting an SD Memory Card or built-in memory will delete all data; however it may still be possible to recover that data using off-the-shelf data recovery software. Please manage your camera's memory at your own risk.
- Please do not press forcefully on the LCD monitor. This could cause breakage or malfunction.
- Be careful not to sit down with the camera in your back pocket as this may damage the exterior of the camera or the LCD monitor.
- When using a tripod with the camera, be careful not to overtighten the screw in the tripod socket on the camera.

# Contents

USING YOUR CAMERA SAFELY .....	1
Care to be Taken During Handling .....	3
Contents .....	5
Composition of the Operating Manual .....	9
<b>Camera Features</b> .....	<b>10</b>
Names of Parts .....	12
Names of Operating Parts .....	13
Monitor Indications .....	13
<b>Getting Started</b> .....	<b>16</b>
<hr/>	
<b>Checking the Contents of the Package</b> .....	<b>16</b>
<b>Attaching the Strap</b> .....	<b>17</b>
<b>Powering the Camera</b> .....	<b>18</b>
Installing the Batteries .....	18
Using the AC Adapter with a Household Power Supply .....	20
<b>Installing the SD Memory Card</b> .....	<b>22</b>
Picture Storage Capacity .....	25
Movie Storage Capacity .....	25
<b>Turning the Camera On and Off</b> .....	<b>26</b>
Turning the Camera On in Capture Mode .....	26
Turning the Camera On in Playback Mode .....	27
<b>Initial Settings</b> .....	<b>28</b>
Selecting the Display Language .....	28
Setting the Date and Time .....	29
<b>Quick Start</b> .....	<b>31</b>
<hr/>	
<b>Taking Still Pictures</b> .....	<b>31</b>
<b>Playing Back Still Pictures</b> .....	<b>33</b>
Playing Back Images .....	33
Playing Back the Previous or Next Image .....	33
Rotating the Displayed Image .....	34
Switching between Capture Mode and Playback Mode .....	35
<b>Common Operations</b> .....	<b>36</b>
<hr/>	
<b>Understanding the Button Functions</b> .....	<b>36</b>
In Capture Mode .....	36
In Playback Mode .....	38
<b>Using the Menu</b> .....	<b>40</b>
How to Set the Menus .....	40
Menu List .....	43

<b>Using the Mode Palettes .....</b>	<b>45</b>
How to Select the Modes.....	45
Mode Palette List.....	45
<b>Taking Pictures .....</b>	<b>48</b>
<b>Taking Pictures in a Selected Mode.....</b>	<b>48</b>
Taking Pictures in the Basic Mode (Green Mode).....	48
Letting the Camera Choose the Optimal Shooting Mode (Auto Picture Mode).....	50
Letting the Camera Choose the Optimal Settings (Program Mode) .....	51
Taking Pictures of People (Portrait Mode/Kids Mode).....	52
Taking Pictures of Your Pet (Pet Mode).....	54
Taking Pictures of Dark Scenes (Night Scene Mode).....	55
Reducing Camera Shake and Blurring When Taking Pictures (Digital SR Mode) .....	56
Framing Your Pictures (Frame Composite Mode).....	57
Taking Panoramic Pictures (Digital Panorama Mode).....	59
<b>Taking Pictures with Customized Settings .....</b>	<b>61</b>
Selecting the Recorded Pixels.....	61
Selecting the Quality Level .....	63
Using the Zoom .....	65
Selecting the Focus Mode .....	67
Selecting the Auto Focus Mode (AF Mode).....	70
Selecting the Flash Mode .....	71
Setting the Sensitivity .....	73
Reproducing the Natural Color of Subject (White Balance) .....	74
Setting the Exposure (EV Compensation).....	76
Adjusting Sharpness, Saturation, and Contrast.....	77
<b>Doing More with Useful Functions .....</b>	<b>78</b>
Displaying Shooting Information.....	78
Using the Self-timer .....	80
Taking a Series of Pictures.....	81
Setting the Date Imprint.....	83
Setting the Instant Review Time.....	84
Saving Your Settings (Memory).....	85
<b>Recording Movies .....</b>	<b>87</b>
Recording a Movie.....	87
Selecting the Settings for Taking Movies .....	89



---

<b>Playing Back Images on the Camera .....</b>	<b>92</b>
Playing Back Still Pictures .....	92
Reviewing Shooting Information.....	92
Nine-Image Display, Folder Display and Calendar Display .....	93
Zoom Playback.....	95
Slideshow .....	96
<b>Playing Back Movies .....</b>	<b>98</b>
Playing Back a Movie .....	98
<b>Playing Back Images on a TV .....</b>	<b>99</b>
<b>Deleting Images and Sound Files.....</b>	<b>100</b>
Deleting a Single Image/Sound File .....	100
Deleting Selected Images and Sound Files (from Nine-Image Display).....	102
Deleting All Images and Sound Files.....	104
Protecting Images and Sound Files from Deletion (Protect) .....	105
<b>Editing and Printing Images .....</b>	<b>107</b>
<b>Editing Images .....</b>	<b>107</b>
Changing the Image Size and Quality (Resize).....	107
Cropping Images .....	109
Copying Images and Sound Files.....	110
Using the Digital Filter .....	112
Using the Brightness Filter .....	113
Adding a Frame (Frame Composite) .....	114
Red-eye Compensation .....	116
<b>Setting the Printing Service (DPOF).....</b>	<b>117</b>
Printing Single Images.....	117
Printing All Images.....	119
<b>Printing Using PictBridge .....</b>	<b>120</b>
Connecting the Camera to the Printer .....	120
Printing Single Images.....	121
Printing All Images.....	123
Printing Using the DPOF Settings .....	124
Disconnecting the Cable from the Printer.....	124
Printing Using ImageLink.....	125

---

<b>Recording Sound (Voice Recording Mode)</b> .....	126
<b>Playing Back Sound</b> .....	128
<b>Adding a Voice Memo to Images</b> .....	129
Recording a Voice Memo .....	129
Playing Back a Voice Memo.....	130
<b>Settings</b> .....	131
<hr/>	
<b>Camera Settings</b> .....	131
Formatting an SD Memory Card or the Built-in Memory .....	131
Changing the Sound Settings.....	132
Changing the Date and Time.....	134
Changing the Display Language .....	136
Changing the Image Folder Name .....	137
Changing the USB Connection Mode.....	138
Changing the Video Output Format.....	139
Adjusting the Brightness of the LCD Monitor.....	140
Using the Power Saving Function .....	141
Setting Auto Power Off .....	142
Setting the Guide Display .....	143
Resetting to Default Settings (Reset) .....	144
Changing the Start-up Screen .....	145
<b>Appendix</b> .....	146
<hr/>	
<b>Default Settings</b> .....	146
<b>Functions Available for Each Shooting Mode</b> .....	149
<b>Optional Accessories</b> .....	150
<b>Messages</b> .....	151
<b>Troubleshooting</b> .....	153
<b>Main Specifications</b> .....	155
<b>WARRANTY POLICY</b> .....	159
<b>Index</b> .....	164

# Composition of the Operating Manual

This Operating Manual contains the following chapters.

## 1 Getting Started

This chapter explains what you need to do after purchasing the camera before you start taking pictures. Be sure to read it and follow the instructions.

## 2 Quick Start

This chapter explains the simplest way to take pictures and play back images. Use it if you wish to start taking pictures or playing back images straightaway.

## 3 Common Operations

This chapter explains common operations such as the functions of the buttons and how to use the menus. For more details, refer to the respective chapters below.

## 4 Taking Pictures

This chapter explains the various ways of capturing images and how to set the relevant functions.

## 5 Playing Back and deleting Images

This chapter explains how to view still pictures and movies on the camera or on a TV and how to delete images from the camera.

## 6 Editing and Printing Images

This chapter explains how to edit taken images using the camera and print still pictures. For saving images to a computer and installing ACDSee for PENTAX, refer to the PC Connection Manual. For details on editing and printing images with a computer, refer to ACDSee for PENTAX Help.

## 7 Recording and Playing Back Sound

This chapter explains how to record sound files or add sound (a voice memo) to an image, and how to play back sound files.



## 8 Settings

This chapter explains how to set the camera-related functions.

## 9 Appendix

This section deals with troubleshooting and lists the optional accessories.

The meanings of the symbols used in this Operating Manual are explained below.

	indicates the reference page number for an explanation of the related operation.
	indicates information that is useful to know.
	indicates precautions to be taken when operating the camera.

1

2

3

4

5

6

7

8

9

9

# Camera Features

The Optio E40 features a variety of shooting modes to suit different situations. Here we briefly describe how to make the most of the key features of your camera. Together with the explanations of camera operations, it will enable you to enjoy your camera to the full.

## Easy-to-Navigate Capture and Playback Functions!

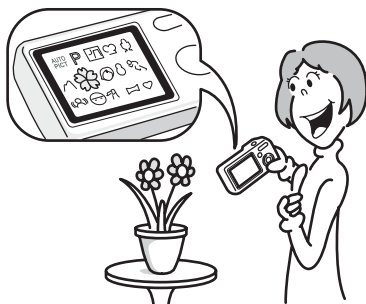

The Optio E40 features an easy-to-see 2.4-inch LCD monitor. In addition, settings for capture, playback and editing functions are easy to navigate. Simply select icons that appear on the LCD monitor. Picture taking has never been simpler in Green Mode. With just one press of a button, you can capture every smile, every moment, and every memory. (p.48)

If you are unsure of which shooting mode to use, select **AUTO PICT** (Auto Picture). The camera selects the appropriate shooting mode depending on the scene. \*(p.50)

\* When you select **AUTO PICT** (Auto Picture mode), a shooting mode is selected from ☺ (Standard mode), 🌃 (Night Scene mode), 🏞️ (Landscape mode), and 👤 (Portrait mode).

- **Let the camera choose the optimal settings.**
- **Use the Green Mode to take pictures easily using standard settings.**

## Have Fun with Adding a Frame to a Picture or Taking Panoramic Pictures!

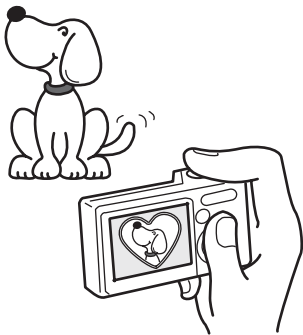

With the Optio E40, you can add a fancy frame when taking a picture of a child or your pet, for example. (p.57) You can also add frames to pictures you have taken. Taking panoramic pictures is also easy, as the camera stitches up to 3 pictures into a panoramic scene. (p.59)

- For decorating your pictures with a frame.
- For capturing a panoramic scene.

## Easy Printing without Using a Computer!

By connecting the camera to a printer that supports PictBridge using the USB/AV cable, you can print images directly from the camera. In addition, by placing the supplied dock insert onto a Kodak EasyShare Printer Dock and then placing the camera on the printer dock, anyone can enjoy printing out images with a touch of a button. Gone are the days of not being able to print out pictures at home because operating the computer was too difficult!

- Easily print out images without using a computer.

## Display Images and Sound Files in Calendar Format!

The Optio E40 lets you display recorded images by date in calendar format. You can easily find the image you wish to play back as you look back at your album. (p.94)

# Names of Parts

## Front

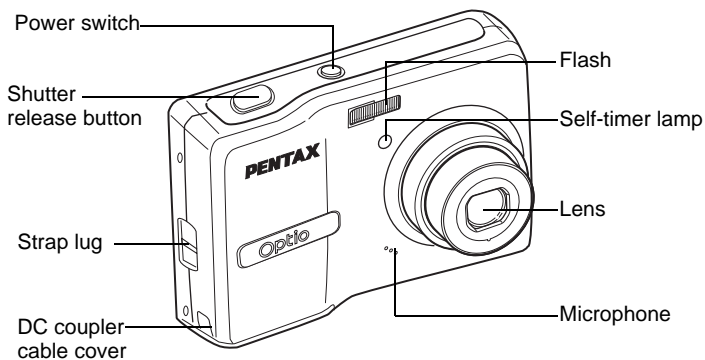

## Back

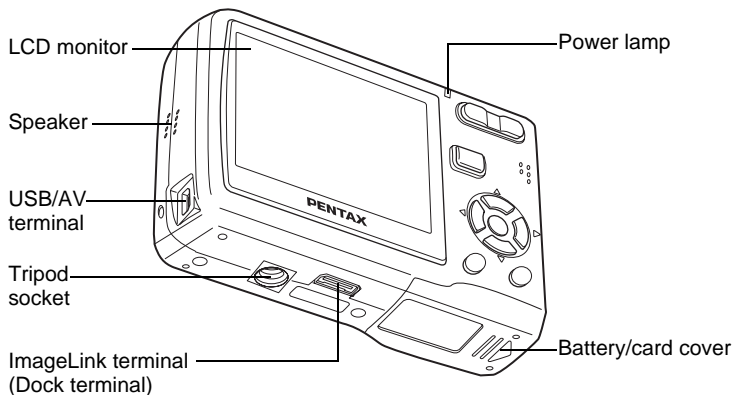

## Names of Operating Parts

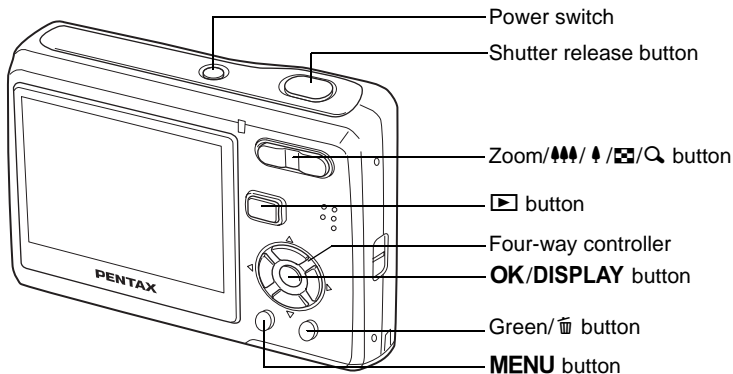





Refer to “Understanding the Button Functions” (p.36 - p.39) for an explanation of the function of each button.

## Monitor Indications

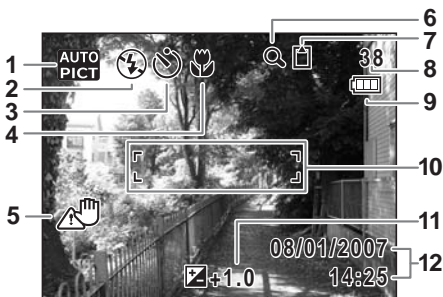
### Normal Display in Still Picture Capture Mode

The display shows information such as the shooting conditions.



- |  |                                    |
|--|------------------------------------|
| 1 Shooting mode (p.45)   | 8 Remaining image storage capacity |
| 2 Flash mode (p.71)  | 9 Battery level indicator (p.19)   |
| 3 Drive mode (p.80 – p.82)   | 10 Focus frame (p.31)              |
| 4 Focus mode (p.67)  | 11 EV compensation (p.76)          |
| 5 Camera shake icon (p.78)   | 12 Date and time (p.29)            |
| 6 Digital zoom icon (p.65)   |                                    |
| 7 Memory status (p.26)   |                                    |
|  : Built-in memory (without card) |                                    |
|  : SD Memory Card                 |                                    |
|  : Card is write-protected        |                                    |

\* 5 appears only when the shutter release button is pressed halfway.

In  (Program Mode), 12 is displayed for two seconds after the camera is turned on.

### Full Display in Still Picture Capture Mode (All of the indications are displayed here for explanatory purposes.)



- |                          |                               |
|--------------------------|-------------------------------|
| 1 Shutter speed          | 5 White balance (p.74)        |
| 2 Aperture               | 6 Sensitivity (p.73)          |
| 3 Recorded pixels (p.61) | 7 Histogram (p.79)            |
| 4 Quality level (p.63)   | 8 Date imprint warning (p.83) |

\* 1 and 2 appear only when the shutter release button is pressed halfway.



## Full Display in Still Picture Playback Mode

(All of the indications are displayed here for explanatory purposes.)

The display shows information such as the shooting conditions. A1 to A11 appear when [Normal Display] or [Histogram + Info] is selected. B1 to B7 appear only when [Histogram + Info] is selected. (p.92)

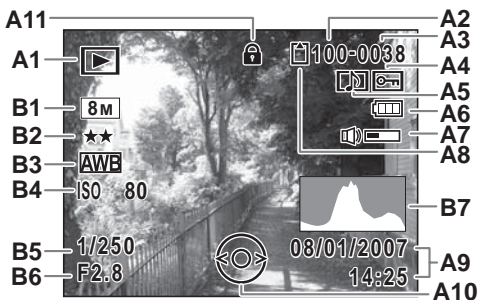

**A1** Playback mode icon (p.47)

**A2** Folder number (p.137)

**A3** File number

**A4** Protect icon (p.105)

**A5** Voice memo icon (p.130)

**A6** Battery level indicator (p.19)

**A7** Volume indicator (p.130)

**A8** Memory status (p.26)

: Built-in memory  
(no card)

: SD Memory Card

: Card is write-protected

**A9** Shooting date and time (p.29)

**A10** Four-way controller operation guide

**A11** Key lock icon (p.49)

**B1** Recorded pixels (p.61)

**B2** Quality level (p.63)

**B3** White balance (p.74)

**B4** Sensitivity (p.73)

**B5** Shutter speed

**B6** Aperture

**B7** Histogram (p.79)

In Normal Display, A6 and A9 disappear if no operation is performed for two seconds.

## Button operation guide

The button operation guide appears on the LCD monitor during operation.

The buttons are indicated as shown below.

Four-way controller (▲)	▲
Four-way controller (▼)	▼
Four-way controller (◀)	◀
Four-way controller (▶)	▶
<b>MENU</b> button	

Zoom button	
<b>OK/DISPLAY</b> button	
Shutter release button	
Green/  button	or

# Checking the Contents of the Package

Check that your camera comes complete with the items listed below.

1



Camera  
Optio E40

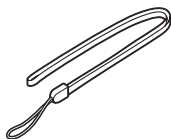

Strap  
O-ST62 (\*)

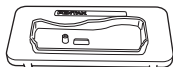

Dock insert  
O-DI69

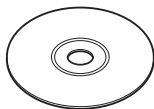

Software (CD-ROM)  
S-SW70

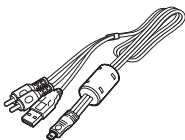

USB/AV cable  
I-UAV62 (\*)



Two AA  
alkaline batteries

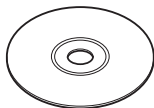

Operating Manual (this manual)  
/ PC Connection Manual  
(CD-ROM)



Quick Guide

Items marked with an asterisk (\*) are also available as optional accessories. For other optional accessories, refer to "Optional Accessories" (p.150).

# Attaching the Strap

Attach the strap (O-ST62) supplied with the camera.

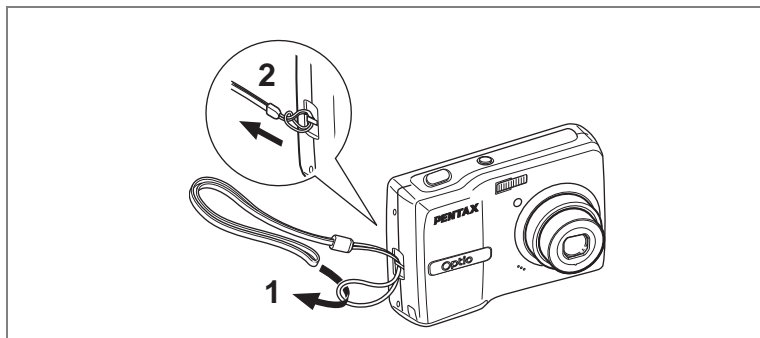

- 1** Pass the narrow end of the strap through the strap lug.
- 2** Pass the other end of the strap through the loop and pull tight.

# Powering the Camera

1

Getting Started

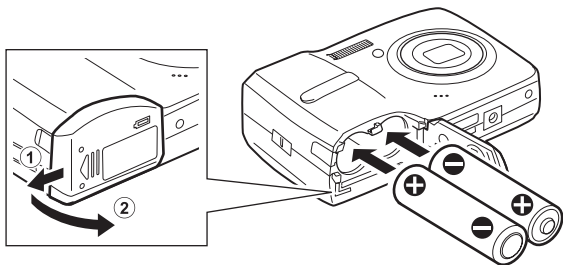

## Installing the Batteries

Install the batteries into the camera. Use two AA alkaline, AA lithium, AA Ni-MH, or AA nickel manganese batteries.

### 1 Open the battery/card cover.

Slide the battery/card cover in the direction ①. The cover will automatically open in the direction ② when you release your fingers from it.

### 2 Insert the batteries, making sure the (+) and (-) on the batteries match the (+) and (-) inside the battery compartment.

### 3 Close the battery/card cover and slide it in the opposite direction of ①.



- AA alkaline, AA lithium and AA nickel manganese batteries are not rechargeable.
- Do not open the battery/card cover or remove the batteries while the camera is turned on.
- If you do not intend to use the camera for a long time, remove the batteries. If the batteries are left in the camera for a long time, they may leak.
- If the batteries have been removed from the camera for a long time, when they are reinserted and the camera is turned on, the message [Battery depleted] may appear. This can also happen when using the camera for the first time; however this is not a malfunction. Wait a minute and then turn the camera on again to reset the camera. The date and time may also be reset.
- Insert the batteries correctly. If the batteries are incorrectly oriented, malfunction may result. If the ends of the batteries look dirty, wipe them before inserting into the camera.



- Use the AC adapter kit K-AC62 (optional) if you intend to use the camera for a long time. (p.20)

## • Image Storage Capacity and Playback Time (at 23°C with the LCD monitor on and fresh AA alkaline batteries inserted)

Image Storage Capacity* <sup>1</sup>	Playback Time* <sup>2</sup>
Approx. 240 pictures	Approx. 400 min.

\*1: Recording capacity shows approximate number of shots recorded during CIPA-compliant testing (with LCD monitor on, flash used for 50% of the shots, and 23°C). Actual performance may vary according to operating conditions.





\*2: According to the result of in-house testing.





- In general, battery performance may temporarily deteriorate as the temperature decreases. Be sure to take spare batteries when using the camera in a cold region and keep the batteries warm by placing them in your pocket or inside your coat. Battery performance that has deteriorated due to cold temperature will return to normal performance when the batteries reach room temperature.
- Due to their characteristics, AA alkaline batteries may not allow the camera to make full use of its capabilities, and therefore they are not recommended except for emergency use.
- Due to their characteristics, AA alkaline batteries and nickel manganese batteries may not allow the camera to make full use of its capabilities when used at cold temperatures. Use of AA lithium batteries is recommended when the camera is used at cold temperatures.
- Be sure to take spare batteries with you when traveling abroad or to a cold region, or if you intend to take a lot of pictures.

## • Battery Level Indicator

You can check the battery level by the  indicator on the LCD monitor.

Screen Display	Battery Status
 (green)	Adequate power remains.
 (green)	Batteries are running low.
 (yellow)	Batteries are running very low.
 (red)	Batteries are exhausted.
[Battery depleted]	The camera will turn off after this message appears.



Due to the characteristics of AA nickel manganese batteries, the battery level may not be displayed correctly when using these batteries.  may be displayed for the battery level even if the batteries are running low. The camera may also turn off without warning even if  is displayed.

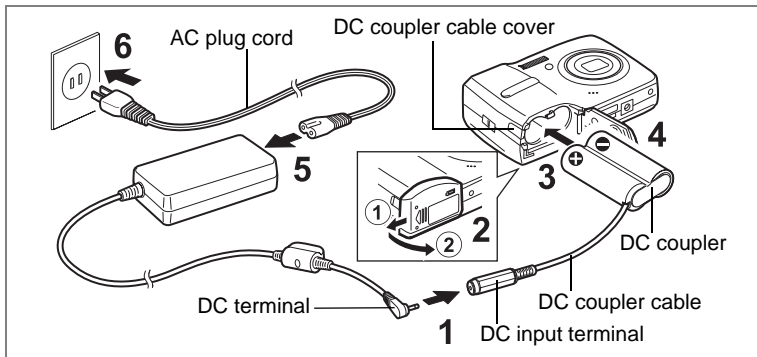

## Using the AC Adapter with a Household Power Supply

Use of the AC adapter kit K-AC62 (optional) with a household power supply is recommended if you intend to use the camera for a long time or connect it to a computer.

- 1** Connect the DC terminal of the AC adapter to the DC input terminal of the DC coupler.
- 2** Make sure that the camera is turned off and open the battery/card cover.  
Slide the battery/card cover in the direction ①. The cover will automatically open in the direction ② when you release your fingers from it.
- 3** Insert the DC coupler into the battery compartment, making sure the (+) and (-) on the coupler match the (+) and (-) inside the battery compartment.
- 4** Open the DC coupler cable cover, pass the DC coupler cable through the opening, and close the battery/card cover.  
Slide the battery/card cover in the opposite direction of ①. Slide the battery/card cover all the way in to make sure it is securely closed.
- 5** Connect the AC plug cord to the AC adapter.
- 6** Plug the AC plug cord into the power outlet.

**Caution**

- Make sure that the camera is turned off before connecting or disconnecting the AC adapter.
- Make sure that the AC plug cord and the power cord connecting the AC adapter to the camera are inserted securely. The data may become lost if either cord becomes disconnected while data is being recorded.
- Use the AC adapter with due care to avoid fire or electric shock. Be sure to read “USING YOUR CAMERA SAFELY” (p.1) before using the AC adapter.
- Be sure to read the operation manual accompanying the AC adapter kit K-AC62 before using the adapter.

# Installing the SD Memory Card

1

Getting Started

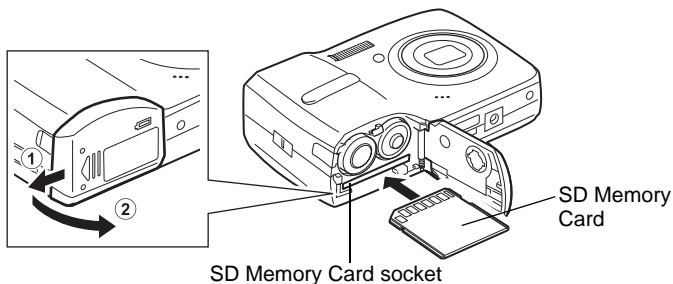

This camera uses either an SD Memory Card or an SDHC Memory Card. (Both cards are referred to as SD Memory Cards hereafter.) Captured images and sound files are saved on the SD Memory Card if a card is inserted in the camera. They are saved in the built-in memory if a card is not inserted.



- Be sure to use this camera to format an SD Memory Card that is unused or has been used on another camera. Refer to “Formatting an SD Memory Card or the Built-in Memory” (p.131) for instructions on formatting.
- Make sure that the camera is turned off before inserting or removing the SD Memory Card.



The still picture storage capacity varies depending on the capacity of the SD Memory Card and the selected number of recorded pixels and quality level. (p.155)

## Backing Up Data

The camera may not be able to access data in the built-in memory in the case of a malfunction. Use a computer or other device to back up important data in another location.



**1 Open the battery/card cover.**

Slide the battery/card cover in the direction ①. The cover will automatically open in the direction ② when you release your fingers from it.

**2 Insert the SD Memory Card into the SD Memory Card socket so that the label is facing toward the LCD monitor.**

Push the card in until it clicks. Images and sound may not be recorded correctly if the card is not inserted all the way.

**3 Close the battery/card cover and slide it in the opposite direction of ①.****Removing the SD Memory Card****1 Open the battery/card cover.****2 Push the card into the SD Memory Card socket to eject it.**

Pull the card out.

## Precautions When Using an SD Memory Card

- The SD Memory Card is equipped with a write-protect switch. Setting the switch to LOCK protects the existing data by prohibiting recording of new data, deletion of existing data or formatting of the card.  appears on the LCD monitor when the card is write-protected.
- Care should be taken when removing the SD Memory Card immediately after using the camera, as the card may be hot.
- Do not remove the SD Memory Card or turn the camera off while data is being saved to the card, images or sound files are being played back, or the camera is connected to a computer with the USB/AV cable, as this may cause the data to be lost or the card to be damaged.
- Do not bend the SD Memory Card or subject it to violent impact. Keep it away from water and store away from high temperature.
- Do not remove the SD Memory Card during formatting as this may damage the card and render it unusable.
- The data on the SD Memory Card may be deleted in the following circumstances. PENTAX does not accept any liability for data that is deleted
  - (1) when the SD Memory Card is mishandled by the user.
  - (2) when the SD Memory Card is exposed to static electricity or electrical interference.
  - (3) when the card has not been used for a long time.
  - (4) when the card is ejected or the batteries are removed while the data on the card is being recorded or accessed.
- If the SD Memory Card is not used for a long time, the data on the card may become unreadable. Be sure to regularly make a backup of important data on a computer.
- Avoid using or storing the card where it may be exposed to static electricity or electrical interference.
- Avoid using or storing the card in direct sunlight or where it may be exposed to rapid changes in temperature or to condensation.
- When using an SD Memory Card with a slow recording speed, recording may stop while you are taking movies even when there is adequate space in the memory, or shooting and playback may take a long time.
- For information on compatible SD Memory Cards, visit the PENTAX website or contact your nearest PENTAX Service Center.

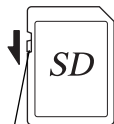

Write-protect switch

## Picture Storage Capacity

Select [Recorded Pixels] and [Quality Level] for still images according to how the images will be used.

For [Recorded Pixels], [8M], [5M], [4M], [3M], [2M], [1024], and [640] are selectable. For [Quality Level], you can select from [★★★ (Best)], [★★ (Better)], and [★ (Good)]. Make your selection on the [📷 Rec. Mode] menu.

Selecting the Recorded Pixels 📄p.61

Selecting the Quality Level 📄p.63

Storage capacity varies depending on the recorded pixels and the quality level you select. For details, see the table on the page indicated below.

Approximate Image Storage Capacity and Recording Time (Still Picture)  
📄p.155

## Movie Storage Capacity

Select [Recorded Pixels] and [Frame Rate] for movies according to how the movies will be used.

For [Recorded Pixels], you can select either [640] or [320]. For [Quality Level], you can select either [30fps] or [15fps]. Make your selection in [Movie] on the [📷 Rec. Mode] menu.

Selecting the Settings for Taking Movies 📄p.89

Storage capacity varies depending on the recorded pixels and the frame rate you select. For details, see the table on the page indicated below.

Movie Storage Capacity 📄p.156

# Turning the Camera On and Off

1

Getting Started

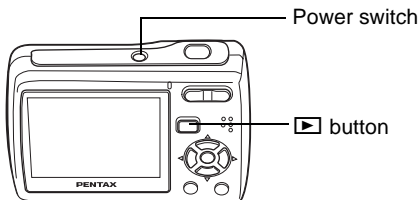

## Turning the Camera On in Capture Mode

### 1 Press the power switch.



The LCD monitor turns on and the lens extends. The camera turns on in  mode (Capture mode).

If [Language/言語] screen or [Date Adjust] screen appears when you turn on the camera, follow the procedures on p.28 to select the display language and/or set current date and time.

### 2 Press the power switch again.

The LCD monitor turns off, the lens closes, and the camera turns off.

## Checking the Memory Card

The memory card is checked automatically when the camera turns on.  appears on the LCD monitor when there is no SD Memory Card inserted in the camera. In this case, images and sound files will be saved in the built-in memory.  appears instead of  when the write-protect switch on the SD Memory Card is in the locked position. Images and sound cannot be recorded when the write-protect switch is locked.

Memory status





If the batteries have been removed from the camera for a long time, when they are reinserted and the camera is turned on, the message [Battery depleted] may appear. This can also happen when using the camera for the first time; however this is not a malfunction. Wait a minute and then turn the camera on again to reset the camera. The date and time and other settings may also be reset. Follow the procedure on p.29 to set these settings again.

## Turning the Camera On in Playback Mode

You can start the Optio E40 in Playback mode with the lens retracted. This is useful when you want to play back saved images and sound straightaway without taking pictures.

**1 Press the power switch while holding down the  button.**

The LCD monitor turns on with the lens retracted. The camera turns on in  mode (Playback mode).

**2 Press the  button again or press the shutter release button halfway.**

The camera switches to  mode (Capture mode).

Playing Back Still Pictures  p.33

# Initial Settings

1

Getting Started

Set the language, time and date before you start taking pictures for the first time.

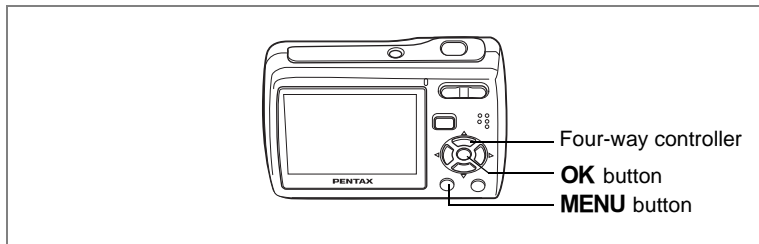

The [Language/言語] screen appears when the camera is turned on for the first time. Follow the procedures in “Selecting the Display Language” below to set the language, and in “Setting the Date and Time” (p.29) to set the current date and time.

Go to “Setting the Date and Time” (p.29) if the [Date Adjust] screen appears.

## Selecting the Display Language

**1 Use the four-way controller (▲▼◀▶) to choose the desired display language.**

**2 Press the OK button.**

The [Date Adjust] screen appears.

Go to “Setting the Date and Time” to set the current date and time and select the display style.



## Setting the Date and Time

Set the current date and time and the display style.

- 1 Press the four-way controller (▶).**

The frame moves to [mm/dd/yy].

- 2 Use the four-way controller (▲▼) to choose the date display style.**

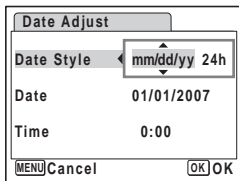

- 3 Press the four-way controller (▶).**

The frame moves to [24h].

- 4 Use the four-way controller (▲▼) to select [24h] (24-hour display) or [12h] (12-hour display).**

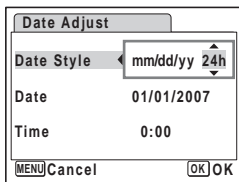

- 5 Press the four-way controller (▶).**

The frame returns to [Date Style].

- 6 Press the four-way controller (▼).**

The frame moves to [Date].

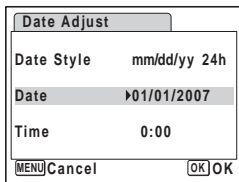

- 7 Press the four-way controller (▶).**

The frame moves to the month.

- 8 Use the four-way controller (▲▼) to change the month.**

Change the day and year in the same manner. Next, change the time.

If you selected [12h] in Step 4, the setting switches between am and pm corresponding to the time.

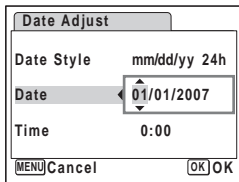

- 9 Press the OK button.**

The camera returns to capture status.



If you press the **MENU** button in the [Date Adjust] screen, you can cancel your setting and start taking pictures right away. However, the [Date Adjust] screen will appear next time you turn on the camera.



- If you press the **OK** button in Step 9, the camera clock is reset to 00 seconds. To set the exact time, press the **OK** button when the time signal (on the TV, radio, etc.) reaches 00 seconds.
- You can change the selected [Language], [Date] and [Time] anytime. See p.136 to change [Language], and p.134 to change [Date] and [Time].
- The video output format is automatically set according to the language you have selected. If the output format is different from the one used in your country or region, refer to “Changing the Video Output Format” (p.139) to change it.

Language	Video Output Format
English (English)	NTSC
French (Français)	PAL
German (Deutsch)	PAL
Spanish (Español)	PAL
Portuguese (Português)	PAL
Italian (Italiano)	PAL
Netherlands (Nederlands)	PAL
Danish (Dansk)	PAL
Swedish (Svenska)	PAL
Finnish (Finnish)	PAL
Polish (Polish)	PAL
Czech (Czech)	PAL
Hungarian (Hungarian)	PAL
Turkish ( Türkçe )	PAL
Russian (Русский)	PAL
Thai (ไทย)	PAL
Korean (한국어)	NTSC
Chinese (traditional) (中文繁體)	PAL
Chinese (simplified) (中文简体)	PAL
Japanese	NTSC



## Taking Still Pictures

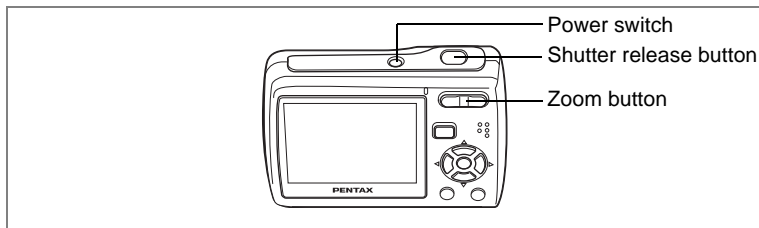

The standard procedure for taking still pictures is described below. The flash discharges automatically depending on the light conditions.

### 1 Press the power switch.

The camera turns on and is ready to take still pictures. In this manual, this is called  mode (Capture mode).

### 2 Compose the picture on the LCD monitor.

The camera will automatically focus on the area within the focus frame. You can change the captured area by pressing the Zoom button.

▲ : enlarges the subject

▲▲▲ : widens the area captured by the camera

### 3 Press the shutter release button halfway.

The color of the focus frame indicates whether the camera focuses clearly on the subject or not.

Green : The subject is in focus.

Red : The subject is out of focus.

Hold the shutter release button and wait until the focus frame turns green.



Focus frame

### 4 Press the shutter release button fully.

The picture is taken.

The image appears on the LCD monitor for 2 seconds (Instant Review) and is saved to the SD Memory Card or the built-in memory. (p.22)



If  [Continuous] is selected for [AF Mode] on the [📷 Rec. Mode] (p.70), the color of the focus frame doesn't change even if the shutter release button is pressed halfway.



- When you turn on the camera, you can take pictures in **AUTO PICT** mode, the default shooting mode. (p.50)
- Press the Green button to switch to the Green Mode and let the camera set all the shooting functions automatically. (p.48)

## 2 Pressing the Shutter Release Button

Press the shutter release button slowly in two steps. This allows for exact focusing as well as preventing camera shake.

### Basic way of shutter release

#### 1 Press the shutter release button halfway.

Lightly press the shutter release button until you feel the click on your finger.

#### 2 Confirm the focus frame on the LCD monitor turns green.

Hold the shutter release button and wait until the focus frame turns green. The camera is in focus.

#### 3 Press the shutter release button fully.

Press it down slowly until the shutter is released.

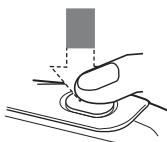

↓  
The camera is in focus.

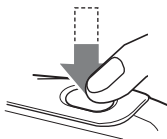

↓  
The picture is taken.



You can also press the shutter release button all the way down (single step) to take pictures. This allows you to release the shutter at the right moment. The pictures are taken as deep-focus (pan focus) shots.

## Playing Back Still Pictures

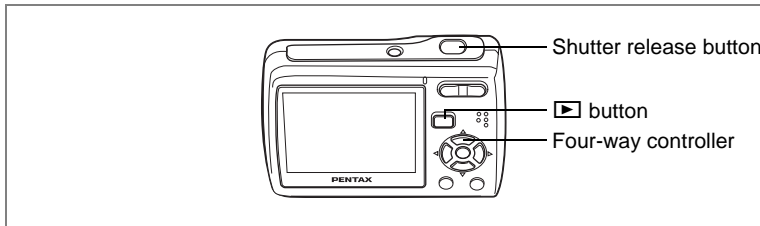

### Playing Back Images

- 1 **Press the ▶ button after taking a picture.**

The image appears on the LCD monitor. In this manual, this is called ▶ mode (Playback mode).

Press the ▶ button again or press the shutter release button halfway to switch to  mode (Capture mode).



### Playing Back the Previous or Next Image

- 1 **Press the ▶ button after taking a picture.**

The image appears on the LCD monitor.

- 2 **Press the four-way controller (◀▶).**

The previous or next image appears.

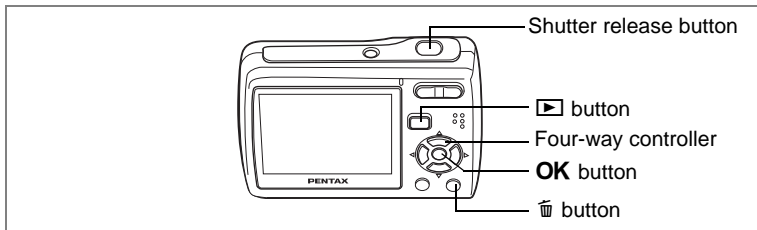

## Rotating the Displayed Image

You can rotate the displayed image. This is useful when you view images taken vertically.

### 1 Press the ▶ button after taking a picture.

The image appears on the LCD monitor.

### 2 Press the four-way controller (▼).

The Playback Mode Palette appears.

### 3 Use the four-way controller (▲▼◀▶) to select ◊ (Image Rotation) and press the OK button.

The rotation selection screen (0°, Right 90°, Left 90°, or 180°) appears.

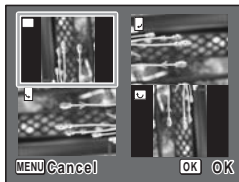

### 4 Use the four-way controller (▲▼◀▶) to choose the rotation direction and press the OK button.

The rotated image appears.



- Panoramic pictures, images taken with the 16-frame shooting function, and movies cannot be rotated.
- Protected images can be rotated, but they cannot be saved in the rotated state.

## Deleting the Displayed Image

- 1 Press the  button when playing back an image.**

The screen for deleting the image appears.

- 2 Press the four-way controller () to select [Delete] and press the OK button.**



The image displayed on the LCD monitor is deleted.

- 3 Press the  button again or press the shutter release button halfway.**

The camera is ready for taking pictures.



## Switching between Capture Mode and Playback Mode

**From  mode (Capture mode) to  mode (Playback mode)**

Press the  button.





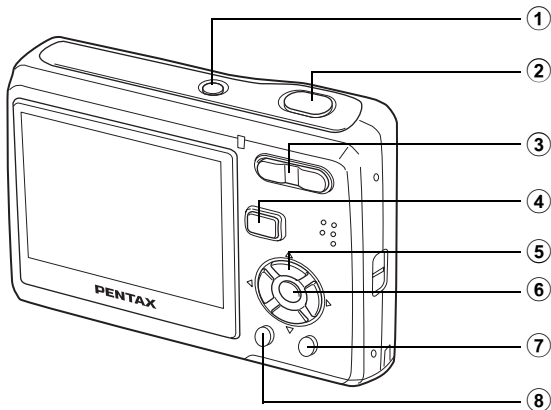

**From  mode (Playback mode) to  mode (Capture mode)**

Press the  button or press the shutter release button halfway.

## Understanding the Button Functions



## In Capture Mode

- ① **Power switch**  
Turns the camera off. (p.26)
- ② **Shutter release button**  
Focuses on the subject when pressed halfway in  mode. (Except in **▲**, **PF** and **MF** modes) (p.67)  
Takes the still picture when pressed down fully. (p.31)  
Starts and stops movie recording in  mode. (p.87)  
Starts and stops sound file recording in  mode. (p.126)
- ③ **Zoom//  button**  
Changes the captured area. (p.65)
- ④ ** button**  
Switches to  mode. (p.35)

## ⑤ **Four-way controller**

(▲) : Changes the drive mode. (p.80, p.81)

(▼) : Displays the Capture Mode Palette. (p.45)

(◀) : Changes the flash mode. (p.71)

(▶) : Changes the focus mode. (p.67)

(▲▼) : Adjusts **MF** in **MF** mode. (p.68)

## ⑥ **OK/DISPLAY button**

Changes the information displayed on the LCD monitor. (p.78)

## ⑦ **Green button**







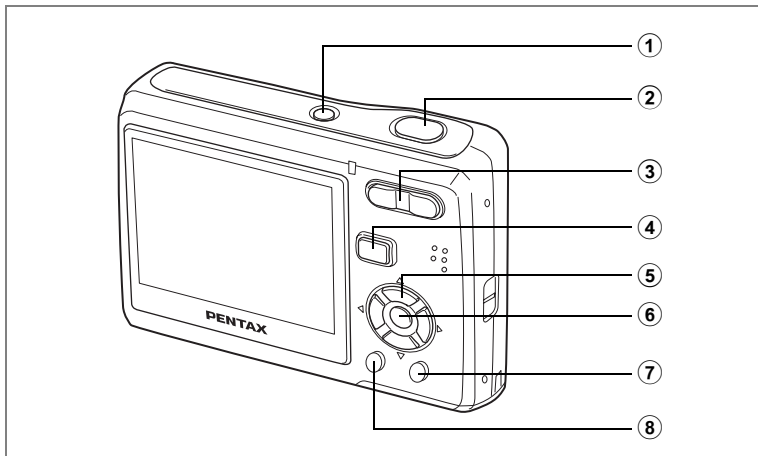



Switches to the Green Mode. (p.48)

## ⑧ **MENU button**

Displays the [📷 Rec. Mode] menu. (p.43)



## In Playback Mode

- ① **Power switch**  
Turns the camera off. (p.26)
- ② **Shutter release button**  
Switches to  mode when pressed halfway. (p.33)
- ③ **Zoom//Quick button**  
Press  during single-image display to change to nine-image display. Returns to the previous display when  is pressed. (p.93)  
Enlarges the image when  is pressed during single-image display. Returns to the previous display when  is pressed. (p.95)  
Press  during nine-image display to change to folder or calendar display. (p.94)  
Press  during folder display to change to nine-image display of the selected folder. (p.94)  
Press  during calendar display to change to nine-image display for the selected date. (p.94)  
Can be used to adjust the volume during playback of movies or sound files. (p.98, p.128)
- ④ ** button**  
Switches to  mode. (p.35)



## ⑤ Four-way controller

- (▲) : Plays back and pauses a movie or sound file. (p.98, p.128)
- (▼) : Displays the Playback Mode Palette. (p.47)  
Stops a movie or sound file during playback. (p.98, p.128)
- (◀▶) : Displays the previous or next image and sound file during single-image display. (p.33)  
Frame forwards, frame reverses and reverses a movie during playback. (p.98)  
Fast forwards, reverses, and moves to the index in sound file playback. (p.128)
- (▲▼◀▶) : Moves the display area during zoom display. (p.95)  
Selects an image in nine-image display, a folder in folder display, and a date in calendar display. (p.93, p.94)  
Moves the image when using the Frame Composite function. (p.114)

## ⑥ OK/DISPLAY button

- Changes the information displayed on the LCD monitor. (p.92)
- Returns zoom display or nine-image display to single-image display. (p.93, p.95)
- Changes to nine-image display of the selected folder during folder display. (p.94)
- Changes to single-image display of the selected date during calendar display. (p.94)





## ⑦ Green/🗑️ button

- Switches from single-image display to the Delete screen. (p.100)
- Switches from nine-image display to the Select & Delete screen. (p.102)
- Switches from folder display to the calendar display screen. (p.94).
- Switches from calendar display to the folder display screen. (p.94)

## ⑧ MENU button

- Displays the [X Setting] menu during single-image display. (p.44)
- Returns to single-image display during Playback Mode Palette display. (p.47)
- Returns zoom display or nine-image display to single-image display. (p.93, p.95)
- Changes to nine-image display of the selected folder during folder display. (p.94)
- Changes to nine-image display of the selected date during calendar display. (p.94)

# Using the Menu

Press the **MENU** button to display the menu on the LCD monitor.  
Press the **MENU** button in  mode to show the [  Rec. Mode ] menu.  
Press the **MENU** button in  mode to show the [  Setting ] menu.

## How to Set the Menus

You can set the menus as shown below. While you are making settings for the menus, the button operation guide appears at the bottom of the LCD monitor to navigate you.

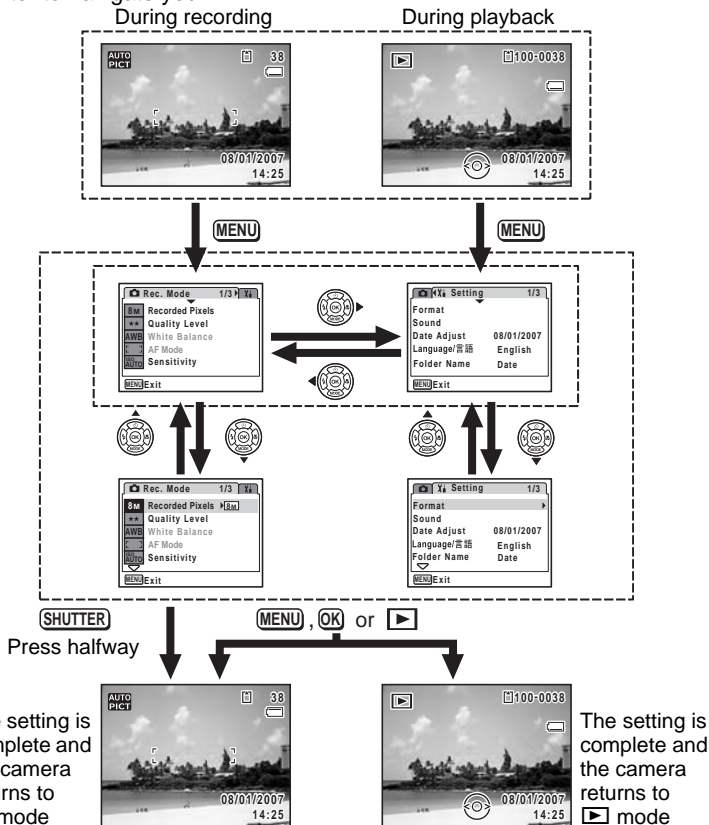

3

Common Operations

Ex.) To set the [Quality Level] on the [Rec. Mode] menu

**1 Press the MENU button in camera mode.**

The [Rec. Mode] menu appears.

**2 Press the four-way controller (▼).**

The frame moves to [Recorded Pixels].

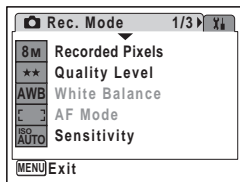

**3 Press the four-way controller (▼).**

The frame moves to [Quality Level].

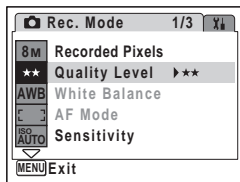

**4 Press the four-way controller (▶).**

A pull-down menu appears with the items that can be selected.

The pull-down menu displays only those items that can be selected with the current camera settings.

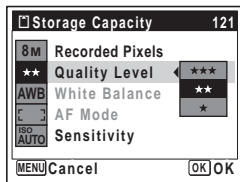

**5 Use the four-way controller (▲▼) to change the setting.**

The quality level changes each time the four-way controller (▲▼) is pressed.

Refer to the following page for instructions on saving settings and canceling changes.

### Saving the Setting and Start Taking Pictures

#### 6 Press the shutter release button halfway.

The setting is saved and the camera returns to capture status.  
When the shutter release button is pressed fully, the picture is taken.

### Saving the Setting and Begin Playback of Images

#### 6 Press the button.

The setting is saved and the camera returns to playback status.

### Saving the Setting and Continue with Menu Operations

#### 6 Press the OK button or the four-way controller (◀).

The setting is saved and the screen returns to Step 3.



### Canceling the Changes and Continue with Menu Operations

#### 6 Press the MENU button.

The changes are canceled and the screen returns to Step 3.

The **MENU** button function differs depending on the screen. Refer to the button operation guide displayed at the bottom of the screen.

 Exit : Exits the menu and returns to the original screen.

  : Returns to Step 3 with the current setting.

 Cancel : Cancels the current selection, exits the menu and returns to Step 3.

## Menu List

This displays the items that can be set with the menus and provides descriptions of each item. See the list of default settings in the Appendix “Default Settings” (p.146) to decide whether you want the settings saved when the camera is turned off and whether you want the settings returned to the defaults when the camera is reset.

### [📷 Rec. Mode] Menu

Item	Description	Page	
Recorded Pixels	For choosing the number of recorded pixels of still pictures	p.61	
Quality Level	For choosing the quality level of still pictures	p.63	
White Balance	For adjusting the color balance according to the light conditions	p.74	
AF Mode	For changing the area for auto focusing	p.70	
Sensitivity	For setting the sensitivity	p.73	
EV Compensation	For adjusting the overall brightness of the picture	p.76	
Movie	Recorded Pixels	For choosing the number of recorded pixels of movies	p.89
	Frame Rate	For setting the frame rate (number of frames per second)	p.90
	Color Mode	For choosing a color mode for movies	p.91
Digital Zoom	For choosing whether to use the digital zoom function	p.66	
Instant Review	For setting the Instant Review time	p.84	
Memory	For choosing whether to save the set values of the shooting function or return to the defaults when the camera is turned off	p.85	
Sharpness	For choosing sharp or soft outlines	p.77	
Saturation	For setting the color saturation	p.77	
Contrast	For setting the image contrast level	p.77	
Date Imprint	For choosing whether to imprint the shooting date on the picture when shooting	p.83	

## [X] Setting] Menu

Item	Description	Page
Format	For formatting the SD Memory Card or built-in memory	p.131
Sound	For adjusting the playback volume and setting the start-up sound, shutter sound, key operation sound and self-timer sound	p.132
Date Adjust	For adjusting the date, time, and date and time styles	p.134
Language/言語	For setting the language in which menus and messages appear	p.136
Folder Name	For choosing how names are assigned to folders for storing images and sound files	p.137
USB Connection	For setting the USB/AV cable connection (to PC or printer)	p.138
Video Out	For setting the output format to the AV equipment	p.139
Brightness Level	For setting the brightness of the LCD monitor	p.140
Power Saving	For setting the time until power saving mode is activated	p.141
Auto Power Off	For setting the time until the camera turns off automatically	p.142
Guide Display	For setting to display guides when an icon is selected in Capture Mode Palette and Playback Mode Palette	p.143
Reset	For returning settings other than the date and time, language, and video out to their defaults	p.144



# Using the Mode Palettes

Press the four-way controller (▼) to display the Mode Palette on the LCD monitor. There are two different Mode Palettes, the “Capture Mode Palette” and the “Playback Mode Palette”.

You can activate a shooting mode most appropriate for the scene or edit taken images just by selecting the icons.

## How to Select the Modes





While you are using the Mode Palettes, refer to the button operation guide displayed at the bottom of the screen.



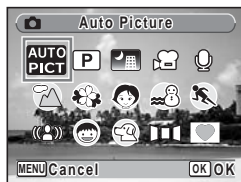







- 1 Press the four-way controller (▼).**  
In  mode, the “Capture Mode Palette” appears.  
In  mode, the “Playback Mode Palette” appears.
- 2 Use the four-way controller (▲▼◀▶) to select an icon.**
- 3 Press the OK button.**  
The screen for the selected mode appears.

## Mode Palette List

### Capture Mode Palette







Item	Description	Page
 Auto Picture mode	Automatically select the best capture mode.	p.50
 Program mode	The basic mode for capturing images. Various functions can also be set with this mode.	p.51
 Night Scene mode	Used for night scenes. Use a tripod, etc. to prevent shaking and use a flash for portraits.	p.55
 Movie mode	For capturing movies. Sound is also recorded.	p.87
 Voice Recording mode	For recording sound only. Be careful not to cover the microphone with your hands.	p.126

Item	Description	Page
 Landscape mode	For capturing landscape views. The camera focuses on a wide range.	–
 Flower mode	For capturing brightly colored flowers. Reproduces the outline of the flower softly.	–
 Portrait mode	For capturing portraits. The skin tone will be brighter to make the person look healthy.	p.52
 Surf & Snow mode	For capturing images with dazzling backgrounds, such as beaches or snowy mountains.	–
 Sport mode	For subjects in fast motion.	–
 Digital SR mode	Higher sensitivity reduces blur.	p.56
 Kids mode	For capturing moving kids. Reproduces healthy and bright skin tone.	p.52
 Pet mode	For capturing images of pets in motion. A setting suitable for the pet's coat can be set.	p.54
 Digital Panorama mode	Stitches images taken with the camera to create a panoramic photograph.	p.59
 Frame Composite mode	For capturing image with frame composite. Recorded pixels is fixed to 3M.	p.57







When you select an icon on the Mode Palette, waiting for about 2 seconds, the description for the selected mode appears. To set not to display the description, see p.143.

## Face Recognition AF&AE

In  (Auto Picture mode),  (Program mode),  (Portrait mode), and  (Kids mode), “Face Recognition AF&AE” is activated.

This function recognizes the subject's face, focuses, and performs exposure compensation when capturing images. The subject is given brighter and healthier look.



- When the camera does not recognize the subject's face in  mode or  mode, the camera will focus on the subject using the AF mode selected in [AF Mode] on the [ Rec. Mode] menu.
- When the camera does not recognize the subject's face in  mode or  mode, the camera will focus on the subject using the standard AF Mode (Multiple).
- The Face Recognition may not work if the subject is wearing sunglasses, has part of the face covered, or is not looking toward the camera.



## Playback Mode Palette



Item	Description	Page	
	Slideshow	For continuously playing back images. Screen or Sound effects can be set.	p.96
	Resize	For changing Recorded Pixels and Quality Level to make the file size smaller.	p.107
	Cropping	For cropping images to the size you like. Saved as a new image.	p.109
	Image/Sound Copy	For copying images and sounds between the built-in memory and SD memory card.	p.110
	Image Rotation	For rotating captured images. Useful when viewing vertical images on a TV.	p.34
	Digital Filter	For modifying images with a Color filter or Soft filter.	p.112
	Brightness Filter	For modifying the brightness of the images.	p.113
	Frame Composite	For merging a frame onto an image. Select to overwrite or save it as a new file.	p.114
	Red-eye Compensation	For compensating red-eye. May not work on some images due to the condition of the image.	p.116
	Voice Memo	For attaching sound to images. Sounds can be recorded until the memory card is full.	p.129
	Protect	Protects images and sounds from accidental deletion. Images can be deleted by formatting.	p.105
	DPOF	For setting the print settings of images. Useful when printing at a printing service.	p.117
	Start-up Screen	For setting a captured image as the Start-up Screen.	p.145



When you select an icon on the Mode Palette, waiting for about 2 seconds, the description for the selected mode appears. To set not to display the description, see p.143.

## Taking Pictures in a Selected Mode

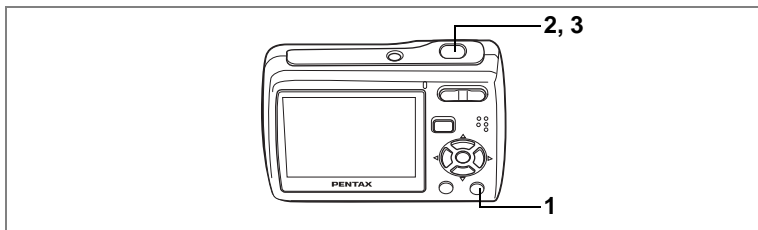
Available in 

4

## Taking Pictures in the Basic Mode (Green Mode)

In the Green Mode, you can enjoy easy picture taking just by pressing the Green button.

**1 Press the Green button in  mode.**

The camera switches to the Green Mode. Press the Green button again to return to the status before the Green Mode was selected.

**2 Press the shutter release button halfway.**

The focus frame on the LCD monitor turns green if the subject is in focus.

**3 Press the shutter release button fully.**

The picture is taken.

Remaining image storage capacity

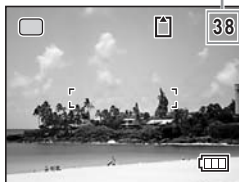



- When the remaining image storage capacity falls below 10, the number on the LCD monitor turns red.
- In Green Mode, you cannot change the information displayed on the LCD monitor by pressing the **OK/DISPLAY** button.
- You cannot use the [Rec. Mode] menu or Capture Mode Palette in Green Mode. If you try to do so, (key lock icon) and a message appear.
- If you switch to [Movie] mode from Green Mode, you cannot display the [Setting] menu by pressing the **MENU** button. If you try to do so, (key lock icon) and a message appear.
- When the camera is turned off in the Green Mode, it turns on in the Green Mode next time the power switch is pressed.



\* The Green Mode settings are as shown below.

Flash Mode	(Auto) <sup>*1</sup>
Drive Mode	(Standard) <sup>*2</sup>
Focus Mode	<b>AF</b> (Standard) <sup>*3</sup>
Information Display	Standard
Recorded Pixels	
Quality Level	★★ (Better)
White Balance	<b>AWB</b> (Auto)
AF Mode	[ ] (Multiple)
Sensitivity	Auto
EV Compensation	±0.0
Digital Zoom	(On)
Instant Review	2 sec
Sharpness	(Standard)
Saturation	(Standard)
Contrast	(Standard)
Date Imprint	<input type="checkbox"/> (OFF)

\*1 Can be set to (Flash Off)

\*2 Can be set to (10 sec. Self-timer) or (2 sec. Self-timer). (The self-timer mode you have selected in a shooting mode other than Green Mode is available.)

\*3 Can be set to (Macro) or **PF** (Pan Focus)

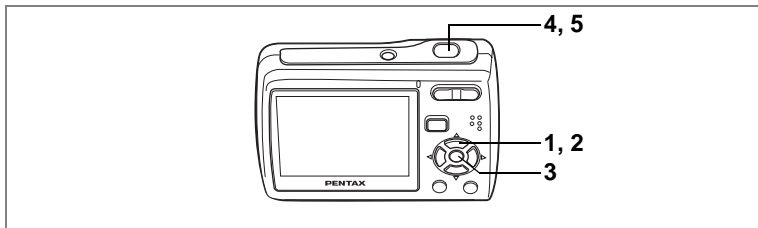
Available in **AUTO PICT**

## Letting the Camera Choose the Optimal Shooting Mode (Auto Picture Mode)

In **AUTO PICT** (Auto Picture mode), when you press the shutter release button, the camera selects the most appropriate mode from 4 shooting modes: ☺ (Normal mode), 🌃 (Night Scene mode), 🏞️ (Landscape mode), and 👤 (Portrait mode).

### 1 Press the four-way controller (▼) in **📷** mode.

The Mode Palette appears.

### 2 Use the four-way controller (▲▼◀▶) to select **AUTO PICT** (Auto Picture).

### 3 Press the OK button.

The shooting mode is selected and the camera returns to capture status.

### 4 Press the shutter release button halfway.

The focus frame on the LCD monitor will light green when the camera is in focus, and the selected mode icon will appear on the top left of the LCD monitor.



### 5 Press the shutter release button fully.



- In **AUTO PICT** mode, the exposure is fixed to  $\pm 0.0$ . (p.76)
- When the camera selects 👤 mode, Face Recognition AF&AE is activated. (p.46)
- The continuous shooting and 16-frame shooting are not available in **AUTO PICT** mode.
- **AUTO PICT** mode is selected as the default shooting mode.

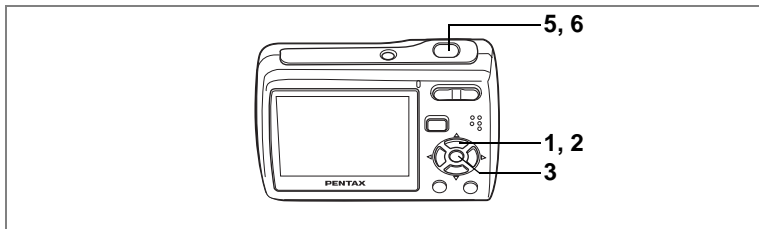

Available in **P**

## Letting the Camera Choose the Optimal Settings (Program Mode)

In **P** (Program mode), the camera automatically sets the shutter speed and aperture for taking still pictures. However, you can select other functions such as the flash mode and recorded pixels.

### 1 Press the four-way controller (▼) in **☞** mode.

The Capture Mode Palette appears.

### 2 Use the four-way controller (▲▼◀▶) to select **P** (Program).

### 3 Press the OK button.

The shooting mode is selected and the camera returns to capture status.

### 4 Set the functions you want to use.

### 5 Press the shutter release button halfway.

The focus frame on the LCD monitor turns green if the subject is in focus.

### 6 Press the shutter release button fully.



The picture is taken.

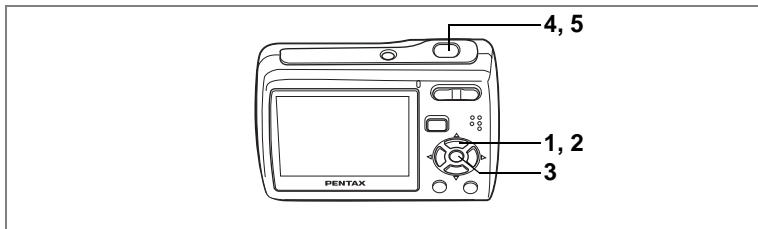

When the subject is recognized as a person in **P** mode, Face Recognition AF&AE is activated. (p.46)

Available in  

## Taking Pictures of People (Portrait Mode/Kids Mode)

In  (Portrait mode) and  (Kids mode), “Face Recognition AF&AE” is activated. This function recognizes faces, focuses, and performs exposure compensation when capturing images. The subject is given brighter and healthier look.

### 1 Press the four-way controller (▼) in mode.

The Capture Mode Palette appears.

### 2 Use the four-way controller (▲▼◀▶) to select (Portrait) or (Kids).

The following procedures are for selecting  mode.

### 3 Press the OK button.

The shooting mode is selected and the camera returns to capture status.

When the camera recognizes the subject's face, a yellow focus frame appears on it. The size and location of the focus frame change while the camera continues to adjust the focus on the moving subject.

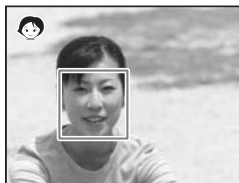



### 4 Press the shutter release button halfway.

The focus frame on the LCD monitor turns green if the subject is in focus.

### 5 Press the shutter release button fully.

The picture is taken.

Caution

- When the camera does not recognize the subject's face, the camera will focus on the subject using the AF mode selected in [AF Mode] on the [📷 Rec. Mode] menu.
- In  mode and  mode, only the selected mode icon and the focus frame appear on the LCD monitor. You cannot change the information displayed on the LCD monitor by pressing the **OK/ DISPLAY** button.
- The Face Recognition may not work if the subject is wearing sunglasses, has part of the face covered, or is not looking toward the camera.

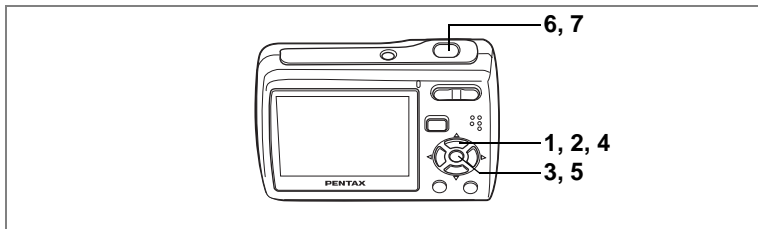

Available in

## Taking Pictures of Your Pet (Pet Mode)

In (Pet mode), your moving pet is automatically kept in focus while you take pictures. You can select the appropriate pet color from white, black and in between according to your pet's coat or fur.

- 1 Press the four-way controller (▼) in mode.**  
The Capture Mode Palette appears.
- 2 Use the four-way controller (▲▼◀▶) to select (Pet).**
- 3 Press the OK button.**  
The Pet mode selection screen appears.
- 4 Use the four-way controller (▲▼) to select , , , , or .**  
There are two types of icons: a cat and dog icon. (Choosing either the cat or dog icon does not affect the resulting picture. Choose whichever you prefer.)
- 5 Press the OK button.**  
The Pet mode is selected and the camera returns to capture status.
- 6 Press the shutter release button halfway.**  
The focus frame on the LCD monitor turns green if the subject is in focus. The focus frame follows the pet while the shutter release button is pressed halfway.
- 7 Press the shutter release button fully.**  
The picture is taken.





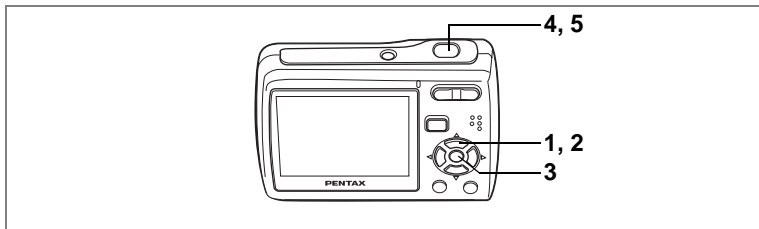

Available in

## Taking Pictures of Dark Scenes (Night Scene Mode)

In (Night Scene mode), you can choose settings appropriate for taking pictures of dark scenes, such as nightscapes.

- 1 Press the four-way controller (▼) in mode.**  
The Capture Mode Palette appears.
- 2 Use the four-way controller (▲▼◀▶) to select (Night Scene).**
- 3 Press the OK button.**  
The shooting mode is selected and the camera returns to capture status.
- 4 Press the shutter release button halfway.**  
The focus frame on the LCD monitor turns green if the subject is in focus.
- 5 Press the shutter release button fully.**  
The picture is taken.



- The continuous shooting and 16-frame shooting are not available in mode.
- The shutter speed tends to be slower when taking pictures of dark scene. To prevent camera shake, it is recommended to shoot using a tripod or self-timer function. (p.80)

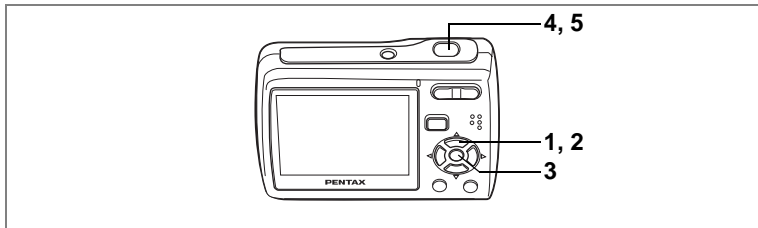

Available in (👤)

## Reducing Camera Shake and Blurring When Taking Pictures (Digital SR Mode)

(👤) (Digital SR mode) allows you to set the sensitivity higher than other modes to reduce camera shake and blurring. Use the mode under the shooting conditions that camera shake or blurring tend to occur.

- 1 Press the four-way controller (▼) in 📷 mode.**  
The Capture Mode Palette appears.
- 2 Use the four-way controller (▲▼◀▶) to select (👤) (Digital SR).**
- 3 Press the OK button.**  
The shooting mode is selected and the camera returns to capture status.
- 4 Press the shutter release button halfway.**  
The focus frame on the LCD monitor turns green if the subject is in focus.
- 5 Press the shutter release button fully.**  
The picture is taken.



When shooting mode is set to (👤), the sensitivity is automatically adjusted between ISO 80 – 1000. (p.73) Shutter speed and aperture are set automatically according to the selected sensitivity.

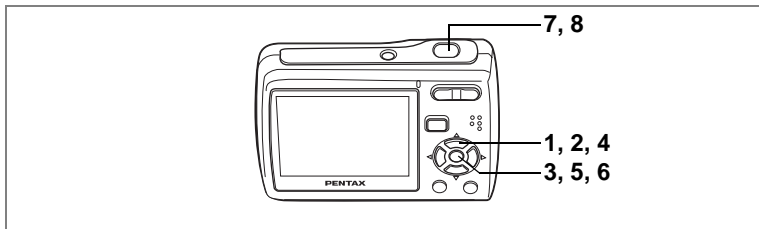





Available in 

## Framing Your Pictures (Frame Composite Mode)

In  (Frame Composite mode), you can display frames stored in your camera, and take a picture with a selected frame.

- 1 Press the four-way controller () in  mode.**



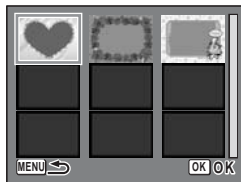

The Capture Mode Palette appears.

- 2 Use the four-way controller (   ) to select  (Frame Composite).**





- 3 Press the OK button.**

A nine-frame display of the frames stored in your camera appears on the LCD monitor.

- 4 Use the four-way controller (   ) to choose the frame you want to use.**

- 5 Press the OK button.**

The selected frame appears in single-image display. You can choose another frame using either of the following operations.

Four-way controller ( ): displays another frame

**MENU** button or Zoom button ()

: returns to the nine-frame display of available frames



- 6 Press the OK button.**

The frame appears on the screen.

## 7 Press the shutter release button halfway.

The focus frame on the LCD monitor turns green if the subject is in focus.

## 8 Press the shutter release button fully.

The picture is taken.



- The number of recorded pixels is fixed at **3M** and the quality level at **★★**.
- The continuous shooting and 16-frame shooting are not available in **♥** mode.

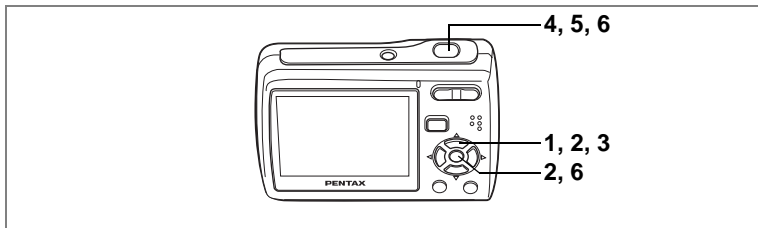

Available in

## Taking Panoramic Pictures (Digital Panorama Mode)

In (Digital Panorama mode), you can stitch 2 or 3 pictures into a panoramic scene (landscape). You do not have to stitch individual pictures on a PC, as the camera automatically stitches them together.

- 1 Press the four-way controller (▼) in mode.**  
The Capture Mode Palette appears.
- 2 Use the four-way controller (▲▼◀▶) to select (Digital Panorama), and press the OK button.**  
The screen to specify the direction you want to pan appears.  
The following procedures are for the case you select “right”.
- 3 Press the four-way controller (▶).**  
The camera is ready for taking the first picture.
- 4 Compose the first picture and press the shutter release button.**  
The first picture is taken.  
After the taken image is displayed on the LCD monitor (Instant Review), the camera is ready for taking the second picture. An “overlay” from the first picture appears at the left 1/4 of the LCD monitor.
- 5 Pan the camera to the right, compose the second picture, and press the shutter release button.**  
Be sure to make the “overlay” cover the same position in the second picture when you compose.  
After the Instant Review of the second picture, the camera is ready for taking the third picture. An “overlay” from the second picture appears at the left 1/4 of the LCD monitor.

## When You Take 2 Pictures Only

### 6 Press the OK button.

After the message “Data being processed” blinks for a while, the stitched picture is displayed on the LCD monitor.

## When You Take 3 Pictures



### 6 Pan the camera to the right, compose the third picture, and press the shutter release button.

Be sure to make the “overlay” cover the same position in the third picture when you compose.

After the message “Data being processed” blinks for a while, the stitched picture is displayed on the LCD monitor.

4



- Focus, exposure, white balance, drive mode, flash mode, and zoom ratio are set with those of the first picture.
- You can re-take the first or second picture. During the Instant Review, press  button, the four-way controller () , and the **OK** button to delete the image, then take a picture again.



When [Instant Review] in [ Rec. Mode] menu is set to Off, no Instant Review is displayed. (p.84)

# Taking Pictures with Customized Settings



Available in

## Selecting the Recorded Pixels

Select Recorded Pixels for still pictures according to how the images will be used.

The larger the number of recorded pixels the higher the quality of images, but the file size becomes larger. The selected Quality Level also affects the size of the image file. (p.63)

### Recorded Pixels

Recorded Pixels	Use
3264x2448	↑ Clearer For printing high quality photos or A4-size pictures, or editing images on a PC.
2592x1944	
2304x1728	
2048x1536	For making postcard-size prints.
1600x1200	
1024x768	For posting on a website or attaching to e-mail.
640x480	

### 1 Press the **MENU** button in mode.

The [ Rec. Mode] menu appears.

### 2 Use the four-way controller ( ) to select [Recorded Pixels].

**3 Press the four-way controller (▶).**

A pull-down menu appears.

**4 Use the four-way controller (▲▼) to change the number of recorded pixels.**

Storage capacity for the selected recorded pixels is also displayed on the screen.

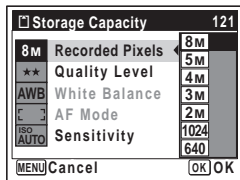
**5 Press the OK button.**

The Recorded Pixels setting is saved.

**6 Press the MENU button.**

The camera returns to capture status with the current setting.



- In mode, recorded pixels is fixed at **2M**.
- In mode, recorded pixels is fixed at **3M**.
- In mode, movies are taken with the recorded pixels set in [Movie] on the [ Rec. Mode] menu. (p.89)

Approximate Image Storage Capacity and Recording Time (Still Picture)  
 p.155



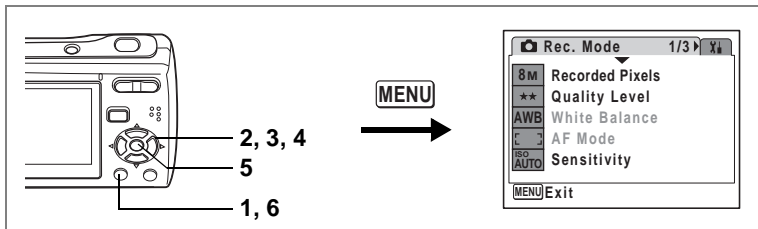

Available in

## Selecting the Quality Level

Select the quality (data compression ratio) for still images according to how the images will be used.

The more ★'s, the higher the quality of images, but the file size becomes larger. The selected Recorded Pixels also affects the size of the image file (p.61).

### Quality Level

★★★	Best	Lowest compression rate. Suitable for photo prints.
★★	Better	Standard compression rate. Suitable for viewing the image on a computer screen.
★	Good	Highest compression rate. Suitable for posting on a website or attaching to e-mail.

- 1 Press the MENU button in mode.**  
The [ Rec. Mode] menu appears.
- 2 Use the four-way controller (▲ ▼) to select [Quality Level].**
- 3 Press the four-way controller (▶).**  
A pull-down menu appears.
- 4 Use the four-way controller (▲ ▼) to change the quality level.**  
Storage capacity for the selected quality level is also displayed on the screen.
- 5 Press the OK button.**  
The Quality Level setting is saved.

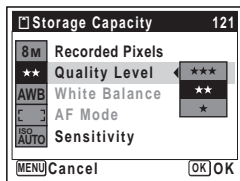

## 6 Press the MENU button.

The camera returns to capture status with the current setting.



In  mode, quality level is fixed at ★★.

Approximate Image Storage Capacity and Recording Time (Still Picture)  
 p.155

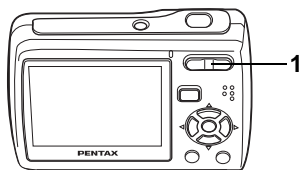

Available in

## Using the Zoom

You can zoom in and out to change the captured area.

### 1 Press the Zoom button in mode.

- ▲ Tele : enlarges the subject
- ▲▲▲ Wide : widens the area captured by the camera

The zoom bar indicates the current status of magnification.

When the digital zoom function is set to  (Off), you can take pictures at up to  $\times 3$  magnification using the optical zoom. When the digital zoom function is set to  (On), you can combine it with the optical zoom to enlarge the subject to a maximum magnification equivalent to  $\times 12$ .



Zoom bar



Optical zoom range      Digital zoom range



- You are recommended to use a tripod to prevent camera shake when taking pictures at a high magnification rate.
- Pictures taken in the digital zoom range appear grainier than pictures taken in the optical zoom range.



## Setting the Digital Zoom

The digital zoom is set to  (On) in the default settings. To take pictures using only the optical zoom, set the digital zoom to  (Off).

**1 Press the MENU button in  mode.**

The [ Rec. Mode] menu appears.

**2 Use the four-way controller ( ) to select [Digital Zoom].**

**3 Use the four-way controller ( ) to select  (On) or  (Off).**

The selected setting is saved.

**4 Press the MENU button.**

The setting is complete and the camera returns to capture status.

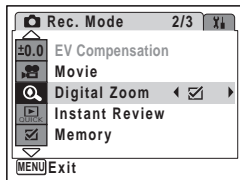

Saving the Digital Zoom Function Setting  p.85

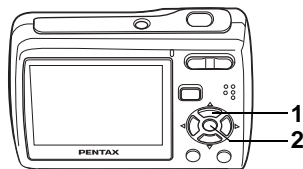

Available in

## Selecting the Focus Mode

Select a focus mode according to the distance between the camera and the subject. If auto-focusing does not work, you can manually focus on the subject.

### Focus Mode

<b>AF</b>	Standard	Select this mode when your subject is more than approx. 40 cm (1.31 ft) away from the camera. When you press the shutter release button halfway, the camera automatically focuses on the subject within the focus frame.
	Macro	Select this mode when your subject is located approx. 15 cm to 40 cm (0.49 ft to 1.31 ft) away from the camera. When you press the shutter release button halfway, the camera automatically focuses on the subject within the focus frame.
	Infinity	This mode is used for taking distant objects. The flash is set to  (Flash Off).
<b>PF</b>	Pan Focus	The pictures are taken as deep-focus (pan focus) shots. It is useful when you ask someone to take pictures for you, or take pictures from the window of a moving car or a train.
<b>MF</b>	Manual Focus	This mode lets you adjust the focus manually.

### 1 Press the four-way controller (▶) in mode.

The focus mode changes each time the button is pressed. You can also change the setting using the four-way controller (▲▼).

### 2 Press the OK button.

The Focus Mode setting is saved and the camera returns to capture status.





- When **AF** (Standard) is selected, the auto-Macro function is activated. When your subject is closer than approx. 40 cm (1.31 ft) from the camera, the camera automatically focuses on the closer subject.
- In mode, you can only select **AF**, or **PF**.
- When you select **AF**, , or **MF** in mode, adjust the focus before recording. Once the recording starts, you cannot adjust the focus.



### About the “auxiliary AF light”

When you attempt auto focusing on a dark subject, the camera may emit orange light toward the subject. This is the “auxiliary AF light”, which helps the camera to focus on the subject under the low light conditions.

The auxiliary AF light of this camera conforms to the safety standard (IEC60825-1) for Class 1 LED product. Looking at the light directly will not create safety hazard. However, do not look into the emitter from a very short distance since you may feel dazzled.

Manual Focus Below  
Saving the Focus Mode p.85

4

## Manual Focus

- 1 Press the four-way controller (▶) in mode.**
- 2 Use the four-way controller (▶) to select MF and press the OK button.**
- 3 Press the four-way controller (▲▼).**

The central portion of the image is magnified to fill the LCD monitor while you are adjusting the focus.

The **MF** indicator appears on the LCD monitor to indicate the approximate distance to the subject. Use the four-way controller (▲▼) to adjust the focus using the indicator as a guide.

- ▲ : for distant focus
- ▼ : for closer focus

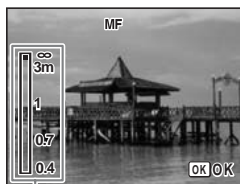
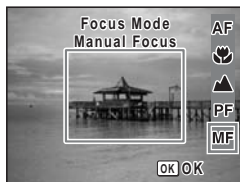

**MF** indicator

## 4 Press the OK button.

The focus is fixed and the camera returns to capture status. If you wish to adjust focus again, press the four-way controller (▶) to display the **MF** indicator.



Shooting mode and drive mode cannot be changed while adjusting **MF**.



To switch from **MF** to another focus mode, press the four-way controller (▶) while the **MF** indicator is displayed.

### Focus lock

When you have difficulty in auto focusing on a subject, try the procedures below.

You may have difficulty in auto focusing on such subjects as:

- Subject contrast is very weak. (blue sky, solid white wall, etc.)
- Dark places, black object, or subject that does not reflect light.
- Subject with strong reflected light, or strong backlight.
- Object with a fine pattern
- Rapidly moving objects
- When a distant object and a close object are both in the focus frame.

**1 Find alternate subject that is in the same distance from the camera as the desired subject.**

**2 Focus on the alternate subject.**

Locate it in the focus frame on the LCD monitor.

**3 Press the shutter release button halfway.**

The focus frame turns green when the alternate subject is in focus.

**4 While holding the shutter release button halfway, move the camera to obtain the desired composition.**

The focus is locked at the point you set in step 3 even if you recompose. (Focus lock)

**5 Press the shutter release button fully.**



Available in

## Selecting the Auto Focus Mode (AF Mode)

You can change the auto focus area or set the camera to focus on a moving subject.

4

Taking Pictures

### AF Mode

	Multiple	The camera focuses on the standard auto focus area.
	Spot	The camera focuses on the smaller auto focus area.
	Continuous	The camera focuses on a moving subject using the smaller auto focus area.

- 1 Press the MENU button in mode.**  
The [ Rec. Mode] menu appears.
- 2 Use the four-way controller ( ) to select [AF Mode].**
- 3 Press the four-way controller ().**  
A pull-down menu appears.
- 4 Use the four-way controller ( ) to change the setting.**
- 5 Press the OK button.**  
The AF Mode setting is saved.
- 6 Press the MENU button.**  
The camera returns to capture status with the current setting.

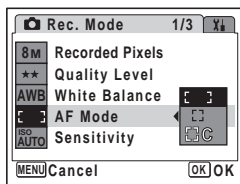

- In mode, [Continuous] cannot be selected.
- In mode, AF Mode is fixed to [Multiple].









### Preventing the “red-eye”

The “red-eye” in flash pictures occurs when the flashlight is reflected in the subject's eyes. To prevent the phenomenon, try the followings.

- Illuminate the subject.
- Set the flash mode to  (Auto + Red-eye) or  (Flash On + Red-eye).

You can also compensate the red-eye pictures using the  (Red-eye Compensation) function of the camera. (p.116)



Available in

## Setting the Sensitivity

You can select the sensitivity to suit the brightness of the surroundings.

### Sensitivity

Auto	Sensitivity is automatically adjusted between ISO 80 – 400. (In Digital SR mode, it is automatically adjusted within the range of ISO 80 – 1000.)
80	<ul style="list-style-type: none"> <li>The lower the sensitivity, the less noise that affects the image. The shutter speed will be slower in low light conditions.</li> <li>Higher sensitivity settings use faster shutter speeds in low light conditions to reduce camera shake, but the image may be affected by noise.</li> </ul>
160	
320	
400	
800	
1000	

#### 1 Press the **MENU** button in mode.

The [ Rec. Mode] menu appears.

#### 2 Use the four-way controller ( ) to select [**Sensitivity**].

#### 3 Press the four-way controller ().

A pull-down menu appears.

#### 4 Use the four-way controller ( ) to change the sensitivity.

#### 5 Press the **OK** button.

The Sensitivity setting is saved.

#### 6 Press the **MENU** button.

The camera returns to capture status with the current setting.

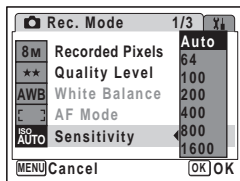

In () mode, the sensitivity is fixed to Auto (ISO 80– 1000).

Saving the Sensitivity p.85



Available in

## Reproducing the Natural Color of Subject (White Balance)

The light condition of the shooting location affects the overall color tone of the pictures. Adjust the white balance to reproduce the natural color of the subject.

### White Balance

<b>AWB</b>	Auto	The camera adjusts the white balance automatically.
	Daylight	Use this mode when taking pictures outside in sunlight.
	Shade	Use this mode when taking pictures outside in the shade.
	Tungsten Light	Use this mode when taking pictures under electric or other tungsten light.
	Fluores. Light	Use this mode when taking pictures under fluorescent light.
	Manual	Use this mode when adjusting the white balance manually.



Set another white balance if you are not satisfied with the color balance of pictures taken with white balance set to **AWB** (Auto).

- Press the MENU button in mode.**  
The [ Rec. Mode] menu appears.
- Use the four-way controller ( ) to select [White Balance].**
- Press the four-way controller ().**  
The White Balance screen appears.
- Use the four-way controller ( ) to change the setting.**
- Press the OK button.**  
The White Balance setting is saved.



## 6 Press the MENU button.

The camera returns to capture status with the current setting. Refer to “Manual Setting” below for adjusting the white balance manually.

Saving the White Balance p.85

### Manual Setting

Have a blank sheet of white paper or similar material for White balance adjustment ready beforehand.

**1 In the White balance screen, use the four-way controller (▲▼) to select (Manual).**

**2 Point the camera at the blank sheet of white paper or similar material for White balance adjustment so that it fits the frame at the center of the LCD monitor.**

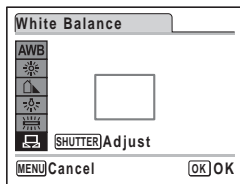

**3 Press the shutter release button fully.**

The white balance is automatically adjusted.

**4 Press the OK button.**

The setting is saved and the screen returns to the [ Rec. Mode] menu.

**5 Press the MENU button.**

The camera returns to capture status.



Available in

## Setting the Exposure (EV Compensation)

You can adjust the overall brightness of the picture.

Use this function to take pictures that are intentionally overexposed or underexposed.

### 1 Press the MENU button in mode.

The [ Rec. Mode] menu appears.

### 2 Use the four-way controller ( ) to select [EV Compensation].

### 3 Use the four-way controller ( ) to select the EV value.

The selected EV value is saved.

To brighten, select a positive (+) value. To darken, select a negative (-) value.

You can choose the EV setting in the range of -2.0 EV to +2.0 EV in 1/3 EV steps.

### 4 Press the MENU button.

The setting is complete and the camera returns to capture status.

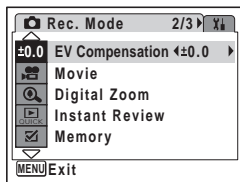

In and modes, the EV compensation is fixed to  $\pm 0.0$ .

Saving the EV Compensation Value p.85



Available in

## Adjusting Sharpness, Saturation, and Contrast

You can adjust the sharpness, saturation, and contrast of image.

Sharpness	Adjust to “-” to soften the image contour and to “+” to sharpen it.
Saturation	Adjust to “-” to reduce the saturation and to “+” to increase it.
Contrast	Adjust to “-” to reduce the contrast and to “+” to increase it.

### 1 Press the **MENU** button in mode.

The [ Rec. Mode] menu appears.

The following procedures are for adjusting [Sharpness].

### 2 Use the four-way controller ( ) to select [Sharpness].

### 3 Use the four-way controller ( ) to change the sharpness level.

Adjust to “+” to sharpen the image contour and to “-” to soften it.

### 4 Press the **MENU** button.

The Sharpness setting is saved and the camera returns to capture status.

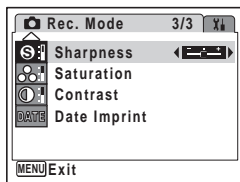

# Doing More with Useful Functions

## Displaying Shooting Information



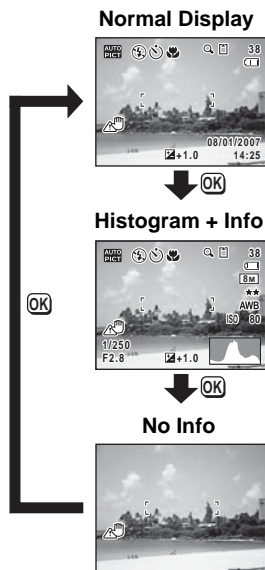

In  mode, you can change the display of shooting information by pressing the **OK/DISPLAY** button. For the meanings of the indications, see p.13.



4

Taking Pictures



- Under the conditions that camera shake tends to occur,  will appear on the LCD monitor when you press the shutter release button halfway. To prevent camera shake, use a tripod and the self-timer function. (p.80)
- In  mode and  mode, only the selected mode icon and the focus frame appear on the LCD monitor. You cannot change the information displayed on the LCD monitor by pressing the **OK/DISPLAY** button.
- In  mode, shooting information is displayed only when you take the first picture. No shooting information will be displayed when you take the second and the third pictures.



## Using the Histogram

A histogram shows the brightness distribution of an image. The horizontal axis represents brightness (dark at the left and bright at the right) and the vertical axis represents the number of pixels.

The shape of the histogram before and after shooting tells you whether the brightness and contrast are correct or not, and lets you decide if you need to use EV compensation and take the picture again.

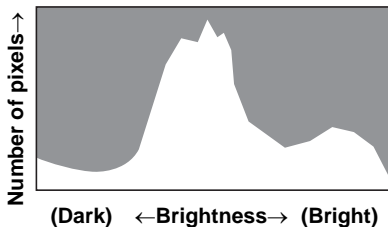

Setting the Exposure (EV Compensation)  p.76

## Understanding Brightness

If the brightness is correct, the graph peaks in the middle. If the image is too dark, the peak is on the left side, and if it is too bright, the peak is on the right side.

Dark image



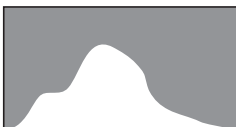

Correct image

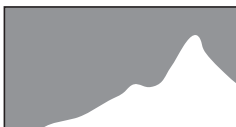

Bright image



Displaying Shooting Information  p.78

Reviewing Shooting Information  p.92

## Understanding Contrast

The graph peaks gradually for images in which contrast is balanced. The graph peaks on both sides but sinks in the middle for images with a large difference in contrast and low amounts of mid-level brightness.



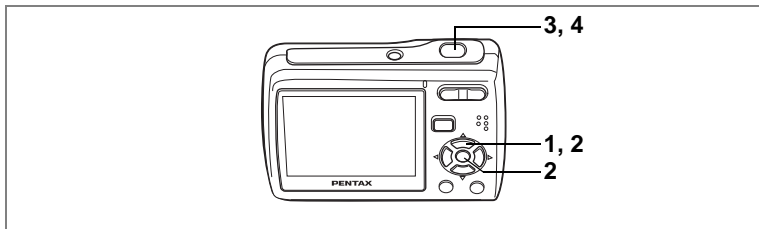

Available in

## Taking a Series of Pictures

You can take several pictures continuously.

	Continuous Shooting	Each time a picture is taken, the image is saved in the memory before the next image is taken.
	16-frame shooting	Takes 16 images per 2 seconds with one press of the shutter release button. The Recorded Pixels is fixed to .

**1 Press the four-way controller (▲) in mode.**

**2 Use the four-way controller (◀▶) to select (Continuous Shooting) or (16-frame shooting) and press the OK button.**

The camera is ready to take a series of pictures.



**3 Press the shutter release button halfway.**

The focus frame on the LCD monitor turns green if the subject is in focus.

**4 Press the shutter release button fully.**

Continuous Shooting : Pictures are taken continuously until you release the shutter release button.

16-frame shooting : 16 images are taken per 2 seconds with one press of the shutter release button.



- In Continuous Shooting and 16-frame shooting, the flash does not discharge.
- The continuous shooting and the 16-frame shooting are not available in , , , , , or mode.
- In mode, only the 16-frame shooting is available. The Continuous Shooting is not available.
- The images shot using the 16-frame shooting function will be printed as one picture with 4 × 4 rows of the 16 images.



- In Continuous Shooting and 16-frame shooting, the focus, exposure, and white balance are fixed with the first image.
- In Continuous Shooting, you can continue shooting until the memory capacity of the SD Memory Card or built-in memory reaches full.
- The interval of continuous shooting will vary depending on the Recorded Pixels and the Quality Level you have selected.
- When you play back the images shot using the 16-frame shooting function, they will be displayed as follows.
  - When played back on the camera, 16 images are continuously played back like a movie. You can play them back in the same way as you play back movies. (p.98)
  - When played back on a PC, the 16 images are arranged in 4 × 4 rows and displayed as a single image.

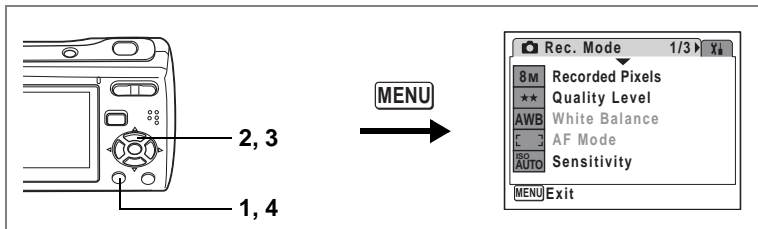

Available in

## Setting the Date Imprint

You can imprint the shooting date on pictures.

- 1 Press the MENU button in mode.**  
The [ Rec. Mode] menu appears.
- 2 Use the four-way controller ( ) to select [Date Imprint].**
- 3 Use the four-way controller ( ) to select  (On) or  (Off).**
- 4 Press the MENU button.**

The camera returns to capture status with the current setting.

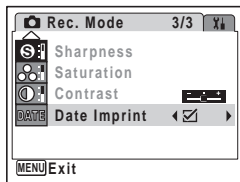

- The date imprinted with this function cannot be deleted.
- The date is imprinted on the picture with the date style selected in the [Date Adjust] menu.
- When [Date Imprint] is set to On, (Date Imprint Warning) icon is displayed on the screen.

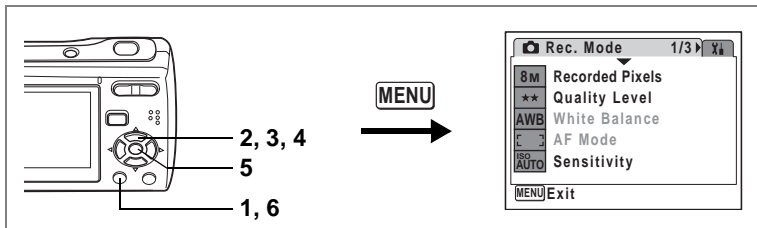

Available in

## Setting the Instant Review Time

You can change the display time of image right after shooting. If you set it longer, you can delete the image while it is displayed on the LCD monitor.

### 1 Press the **MENU** button in mode.

The [ Rec. Mode] menu appears.

### 2 Use the four-way controller ( ) to select [Instant Review].

### 3 Press the four-way controller ().

A pull-down menu appears.

### 4 Use the four-way controller ( ) to change the display time.

### 5 Press the **OK** button.

The Instant Review setting is saved.

### 6 Press the **MENU** button.

The camera returns to capture status with the current setting.

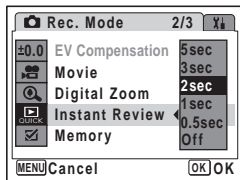

Instant Review p.31

## Saving Your Settings (Memory)

The Memory function is for saving the current camera settings even when the camera is turned off.

For some camera settings, the Memory function is always set to  (On) (the settings are saved when the camera is turned off), while for others you can choose on or off (to choose whether the settings are saved or not when the camera is turned off). The items which can be set to  (On) or  (Off) in the Memory function are shown in the table below. (Items not listed here will be saved in the selected settings when the camera is turned off.) If you select  (On), the settings will be saved in the status they were in immediately before the camera was turned off. If you select  (Off), the settings will be reset to the defaults when the camera is turned off. The table below also shows whether the Memory default setting for each item is on or off.

Item	Description	Default Setting
Flash Mode	The flash mode set with the four-way controller (◀) (p.71)	<input checked="" type="checkbox"/>
Drive Mode	The drive mode set with the four-way controller (▲) (p.80, p.81)	<input type="checkbox"/>
Focus Mode	The focus mode set with the four-way controller (▶) (p.67)	<input type="checkbox"/>
Zoom Position	The zoom position set with the Zoom/⏏/⏏ button (p.65)	<input type="checkbox"/>
MF Position	The manual focus position set with the four-way controller (▲▼) (p.68)	<input type="checkbox"/>
White Balance	The [White Balance] setting on the [📷 Rec. Mode] menu (p.74)	<input type="checkbox"/>
Sensitivity	The [Sensitivity] setting on the [📷 Rec. Mode] menu (p.73)	<input type="checkbox"/>
EV Compensation	The [EV Compensation] setting on the [📷 Rec. Mode] menu (p.76)	<input type="checkbox"/>
Digital Zoom	The [Digital Zoom] setting on the [📷 Rec. Mode] menu (p.66)	<input checked="" type="checkbox"/>
DISPLAY	The LCD monitor information display mode set with the <b>OK/DISPLAY</b> button (p.78, p.92)	<input type="checkbox"/>
File No.	If a new SD Memory Card is inserted when On has been selected, file numbers are assigned sequentially.	<input checked="" type="checkbox"/>

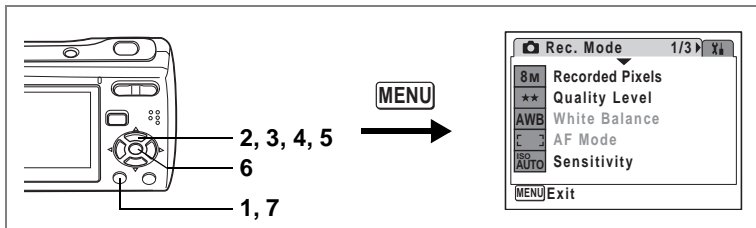

**1 Press the MENU button in  mode.**



The [ Rec. Mode] menu appears.

**2 Press the four-way controller ( ) to select [Memory].**

**3 Press the four-way controller ().**

The Memory screen appears.

**4 Use the four-way controller ( ) to choose an item.**

**5 Use the four-way controller ( ) to select  (On) or  (Off).**

**6 Press the OK button.**

The Memory setting is saved.

**7 Press the MENU button.**

The camera returns to capture status with the current setting.

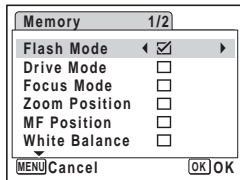





### 3 Press the OK button.

 mode is selected and the camera is ready for recording movies. The following information appears on the LCD monitor.

- 1 Movie mode icon
- 2 Focus mode icon
- 3 Recording indicator (appears when recording begins in step 4 and blinks during recording)
- 4 Remaining recordable time
- 5 Current date and time
- 6 Focus frame (does not appear during recording)



You can change the captured area by pressing the Zoom button to the left or right.



 : enlarges the subject

 : widens the area captured by the camera

### 4 Press the shutter release button fully.

Recording starts. You can record movie continuously until the built-in memory/SD Memory Card reaches full or max. 2GB.



- The flash will not discharge in  mode.
- You can use the optical zoom and digital zoom before starting to record, and the digital zoom while recording.
- When the focus mode is set to **AF**, , or **MF**, you can adjust the focus before recording starts.
- You can switch shooting information on the LCD monitor with **OK/DISPLAY** button during recording. However, histogram will not appear for movies.

### 5 Press the shutter release button fully.

Recording stops.

Playing Back Movies  p.98

#### Keeping the Shutter Release Button Pressed

If you keep the shutter release button pressed for more than one second, recording will continue as long as you keep the button pressed. Shooting stops when you take your finger off the shutter release button.



Available in

## Selecting the Settings for Taking Movies

You can select [Recorded Pixels], [Frame Rate], and [Color Mode] for your movies.

- 1 Press the **MENU** button in mode.  
[ Rec. Mode] menu appears.
- 2 Use the four-way controller ( ) to select [Movie].
- 3 Press the four-way controller ().  
The menu for movie setting appears.

### Selecting the Recorded Pixels of Movies

The more pixels are selected, the larger the data size. The data size also varies depending on the frame rate you select.

#### Recorded Pixels

 (640×480)	High-quality movies. Suitable for viewing on a TV or a PC.
 (320×240)	Suitable for posting on a website or attaching to an e-mail.

- 4 Use the four-way controller ( ) to select [Recorded Pixels].

**5 Press the four-way controller (▶).**

The pull-down menu appears.

**6 Use the four-way controller (▲▼) to change the recorded pixels.**

Recordable time for the selected recorded pixels is also displayed on the screen.

**7 Press the OK button.**

Your selection is saved.

**8 Press the MENU button twice.**

The camera returns to capture status with the current setting.

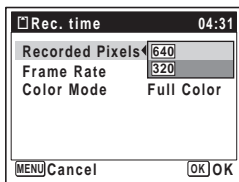
**Selecting the Frame Rate**

The frame rate determines how smoothly the movie is played back. The “fps” indicates the number of frames taken per a second. The more frames, the better the quality of the movie, but the data size becomes larger.

**4 Use the four-way controller (▲▼) to select [Frame Rate].****5 Press the four-way controller (▶).**

The pull-down menu appears.

**6 Use the four-way controller (▲▼) to change the frame rate.**

Recordable time for the selected frame rate is also displayed on the screen.

**7 Press the OK button.**

Your selection is saved.

**8 Press the MENU button twice.**

The camera returns to capture status with the current setting.

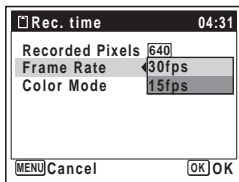

## Recording Movies in Black and White or in Sepia Tones (Color Mode)

Select the color tone of your movies from [Full Color], [B&W], and [Sepia].

**4 Use the four-way controller (▲▼) to select [Color Mode].**

**5 Press the four-way controller (▶).**

The pull-down menu appears.

**6 Use the four-way controller (▲▼) to change the color mode.**

**7 Press the OK button.**

Your selection is saved.

**8 Press the MENU button twice.**

The camera returns to capture status with the current setting.

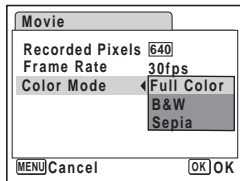

You cannot change the color mode of movies after recording.

Movie Storage Capacity p.156

# Playing Back Images on the Camera

## Playing Back Still Pictures

To play back still pictures, press button in mode to switch to mode (Playback mode). For details, see “Playing Back Images” (p.33). For playing back movies, see “Playing Back a Movie” (p.98).

## Reviewing Shooting Information

In mode, you can change the display of shooting information on the played back image by pressing the **OK/DISPLAY** button. For the meanings of the indications, see p.15.

Normal Display



Histogram + Info

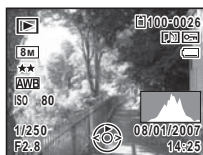

No Info



Displaying Shooting Information p.78

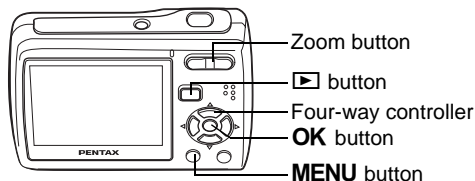

## Nine-Image Display, Folder Display and Calendar Display

### Nine-Image Display

You can display nine captured images on the LCD monitor at a time.

#### 1 In mode, press on the Zoom button.

A page consisting of nine thumbnail images appears. The displayed images change nine at a time page by page.

Use the four-way controller (, , , ) to move the selection frame. When 10 or more images have been saved, if you choose image ① and press the four-way controller (, ), the previous page appears. Similarly, if you choose image ② and press the four-way controller (, ), the next page appears.

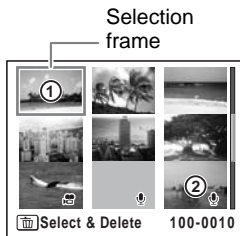

The icons that appear on the images indicate the following:

- No icon : Still picture without sound
- (with image) : Still picture with sound
- : Movie (first frame appears)
- (without image) : Sound file only

#### 2 Press the OK button.

The single-image display of the selected image is displayed. You can also use the **MENU** button or on the Zoom button to display it.

## Switching to Folder Display or Calendar Display

In nine-image display, press  on the Zoom button to switch to folder display or calendar display. Press the Green button to switch between folder display and calendar display.

### 1 In mode, press on the Zoom button.





The screen changes to nine-image display.

### 2 Press on the Zoom button.

The screen changes to folder display or calendar display.

#### Folder display

Folders with recorded images and sound files appear.

Use the four-way controller (   ) to move the selection frame.

Select a folder and press  on the Zoom button or **OK** button to switch to nine-image display with the first image in the folder selected.

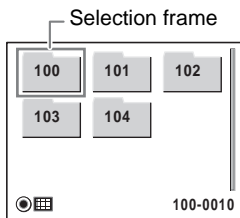





#### Calendar display

Recorded images and sound files are displayed by date in calendar format.

The first image recorded on a date is displayed for that date on the calendar.



 appears for dates on which a sound file was first recorded.

Use the four-way controller (   ) to move the selection frame.

Select a date and press  on the Zoom button to switch to nine-image display with the first image from that date selected.

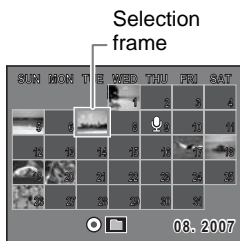
Select a date and press the **OK** button to switch to single-image display of the first image recorded on that date.





- Press the **MENU** button in folder display or calendar display to switch to normal nine-image display.
- Press the  button or the shutter release button in folder display or calendar display to switch to  mode.

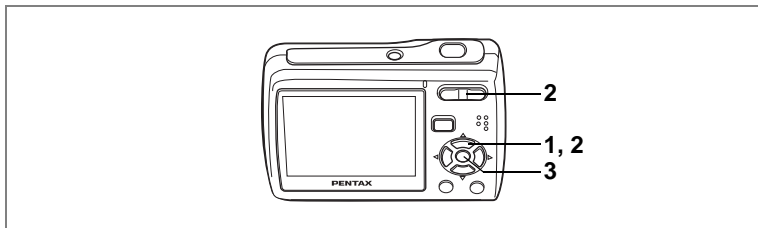



## Zoom Playback

You can magnify an image up to  $\times 8$ . A guide showing the center of the magnified portion of the image appears on the LCD monitor during zoom playback.

**1 Enter the  mode and use the four-way controller ( ) to choose the image you want to magnify.**







**2 Press  on the Zoom button.**

The image is magnified ( $\times 1.1$  to  $\times 8$ ). Holding down  on the Zoom button changes the magnification continuously. You can use the guide at the bottom left of the screen to check which portion of the image is magnified.



Guide

**The following operations can be performed while the magnified image is displayed.**

- |   |   |
|---|---|
| Four-way controller (     ) | Moves the position to be magnified        |
| Zoom button (  )   | Enlarges the image (max. $\times 8$ )     |
| Zoom button (  )   | Diminishes the image (min. $\times 1.1$ ) |

**3 Press the OK button.**

The image returns to single-image display.





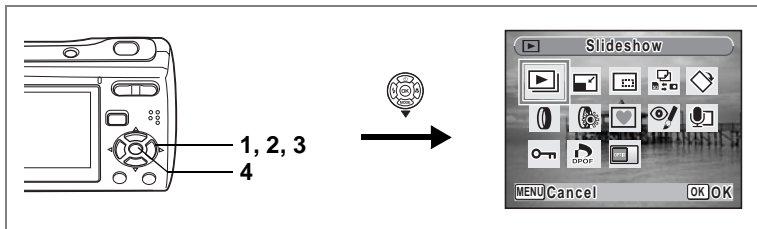





- Images taken with the 16-frame shooting function and movies cannot be magnified.
- The guide does not appear if the shooting information display is set to “No Info”.



## Slideshow

You can play back recorded images one after another.

- 1 Enter the  mode and use the four-way controller ( ) to choose an image to start the slideshow with.**
- 2 Press the four-way controller ().**  
The Playback Mode Palette appears.
- 3 Use the four-way controller (   ) to select  (Slideshow).**
- 4 Press the OK button twice.**  
The slideshow starts.  
Pressing the **OK** button during the slideshow pauses the slideshow. To resume the slideshow, press the **OK** button while the slideshow is paused.
- 5 Press any button other than the OK button or the power switch.**  
The slideshow stops.



If you press the four-way controller () while playing back a movie or picture with sound, the next image is displayed without ending the slideshow.

## Setting the Slideshow Conditions

You can set the playback interval and also a screen effect and sound effect for when one image changes to the next.

- 1 Press the four-way controller () in  mode.**  
The Playback Mode Palette appears.
- 2 Use the four-way controller (   ) to select  (Slideshow).**

**3 Press the OK button.**

The screen for setting the slideshow conditions appears.

**4 Use the four-way controller (▲▼) to select [Interval].****5 Press the four-way controller (▶).**

A pull-down menu appears.

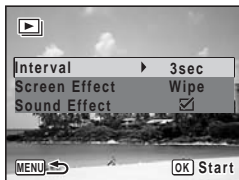
**6 Use the four-way controller (▲▼) to change the interval and press the OK button.**

You can choose from 3sec, 5sec, 10sec, 20sec, and 30sec.

**7 Use the four-way controller (▲▼) to select [Screen Effect].**

After selecting [Screen Effect], press the four-way controller (▶).

A pull-down menu appears with the following items that can be selected. Use the four-way controller (▲▼) to select an item and press the **OK** button.

Off	No effect
Wipe	The next image slides over the previous one from left to right
Checker	The next image appears in small square mosaic blocks
Fade	The current image gradually fades out and the next image fades in

**8 Use the four-way controller (▲▼) to select [Sound Effect].****9 Use the four-way controller (◀▶) to select  (On) or  (Off).**

Except when the screen effect is set to Off, you can choose  (On) or  (Off) for the sound that is played when one image changes to the next.

**10 Press the OK button.**

The slideshow starts using the selected interval and effect.



- The slideshow will continue until you press any button other than the **OK** button or the power switch.
- Movies or pictures with sound will normally be played through to the end before the next picture is played back, regardless of the interval setting. However, pressing the four-way controller (▶) while playing back a movie or a picture with sound skips to the next image.
- Sound files made in Voice Recording mode are not played back in the slideshow.
- Panoramic pictures are played back scrolling for 5 seconds regardless of your setting on [Interval].

# Playing Back Movies

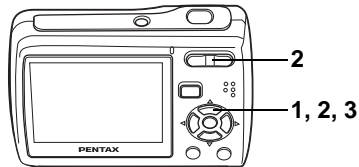

## Playing Back a Movie

You can play back the movies you have taken. Sound is played back at the same time.

**1** Enter the  mode and use the four-way controller (◀▶) to choose the movie you want to play back.

**2** Press the four-way controller (▲).

Playback starts.

Press the four-way controller (▲) again to pause.



**The following operations can be performed during playback.**

- |                         |                      |
|-------------------------|----------------------|
| Four-way controller (◀) | Reverse playback     |
| Four-way controller (▲) | Pause                |
| Zoom button (⬆)         | Increases the volume |
| Zoom button (⬆⬆⬆)       | Reduces the volume   |

**The following operations can be performed while playback is paused.**

- |                         |                                    |
|-------------------------|------------------------------------|
| Four-way controller (◀) | Frame reverse                      |
| Four-way controller (▶) | Frame forward                      |
| Four-way controller (▲) | Releases the Pause function (Play) |

**3** Press the four-way controller (▼).

Playback stops.



You can play back images taken with the 16-frame shooting function in the same way as you play back movies.

# Playing Back Images on a TV

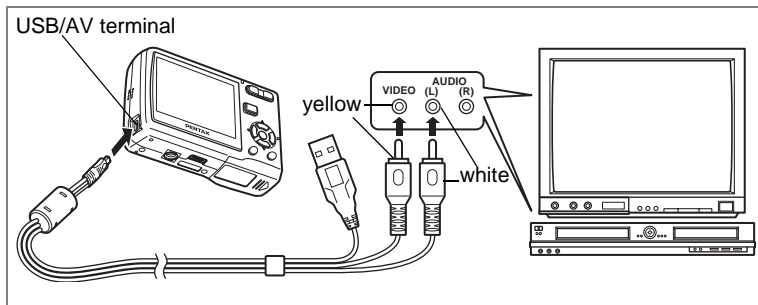

By connecting your camera to a TV or other AV equipment using the supplied USB/AV cable, you can display images on the monitor for review or picture taking.

- 1 Connect the supplied USB/AV cable to the USB/AV terminal on the camera.**
- 2 Connect the other ends of the USB/AV cable (yellow: video, white: audio) to the video input terminal and audio input terminal on the AV equipment.**

When using stereo sound equipment, insert the sound terminal into the L (white) terminal.

- 3 Turn the AV equipment on.**

When the equipment that the camera is connected to and the equipment that plays back images are different, turn both equipment on.

When viewing images on AV equipment with multiple video input terminals (such as a TV), refer to the operation manual of the equipment and select the video input terminal to which the camera is connected.

- 4 Turn the camera on.**



- You are recommended to use the AC adapter kit K-AC62 (optional) if you intend to use the camera for a long time. (p.20)
- Depending on the country or region, images and sound files may fail to be played back if the video output format is set different from the one in use there. If this happens, change the video output format setting. (p.139)
- The LCD monitor of the camera turns off while it is connected to AV equipment. You cannot adjust sound volume using the Zoom button on the camera.

# Deleting Images and Sound Files

Delete images and sounds that are with mistakes or unnecessary.

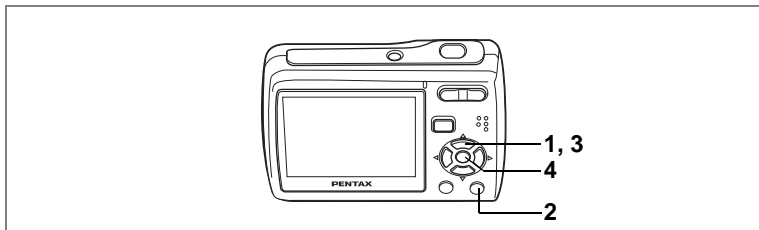







## Deleting a Single Image/Sound File

You can delete a single image and sound file.

5



Protected images and sound files cannot be deleted. (p.105)



- 1 Enter the  mode and use the four-way controller ( ) to choose the image/sound file you want to delete.**
- 2 Press the  button.**  
The confirmation screen appears.
- 3 Use the four-way controller ( ) to select [Delete].**
- 4 Press the OK button.**  
The image or sound file is deleted.



If you press the  button during Instant Review, the screen in Step 2 appears, enabling you to delete the image you have just taken. (p.35)

## Deleting a Sound File

If sound has been recorded with an image (p.129), you can delete the sound without deleting the image.

**1** Enter the  mode and use the four-way controller ( ) to choose an image with sound.

**2** Press the  button.

The confirmation screen appears.

**3** Use the four-way controller ( ) to select [Delete Sound].

**4** Press the **OK** button.

The sound file is deleted.



Select [Delete] in Step 3 above to delete both the image and sound file.

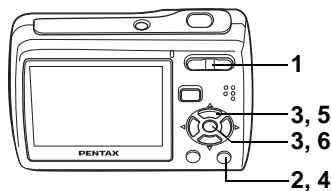

## Deleting Selected Images and Sound Files (from Nine-Image Display)

You can delete several images/sound files selected from the nine-image display at once.



Protected images and sound files cannot be deleted.

5

- 1 In mode, press on the Zoom button.**

Nine thumbnail images appear.

- 2 Press the button.**

appears on the images and sound files.

- 3 Use the four-way controller (, , , ) to choose the images and sound files that you want to delete and press the OK button.**

appears on the selected images and sound files.

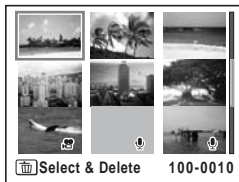

If you select an image and press on the Zoom button, the selected image is displayed in single-image display while you are holding the button, enabling you to check whether you want to delete it or not. (The display returns to the nine-image display when you release the button.) However, protected images cannot be displayed in single-image display.





**4 Press the  button.**

A confirmation dialog appears.

**5 Use the four-way controller ( ) to select [Select & Delete].**

**6 Press the OK button.**

The selected images and sound files are deleted.



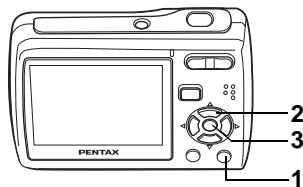

## Deleting All Images and Sound Files

You can delete all the images and sound files at once.



Protected images and sound files cannot be deleted. (p.105)

### 1 Press the button twice in mode.

A confirmation dialog appears.

### 2 Use the four-way controller ( ) to select [Delete All].

### 3 Press the **OK** button.

All the images and sound files are deleted.

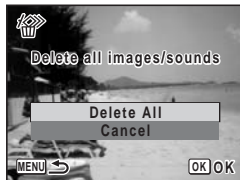

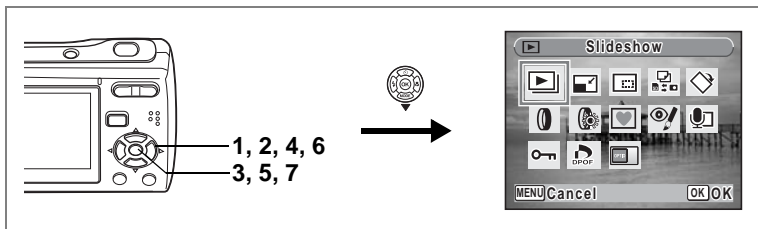

## Protecting Images and Sound Files from Deletion (Protect)

You can protect stored images and sound files from being accidentally deleted.

- 1 Press the four-way controller (▼) in [▶] mode.**  
The Playback Mode Palette appears.
- 2 Use the four-way controller (▲▼◀▶) to select [Protect].**
- 3 Press the OK button.**  
The screen for selecting [Select image/sound] or [All Images/Sounds] appears.
- 4 Use the four-way controller (▲▼) to select [Select image/sound].**
- 5 Press the OK button.**  
The message [Protect this image/sound] appears. To protect another image or sound file, use the four-way controller (◀▶) to select another image or sound file.
- 6 Use the four-way controller (▲▼) to select [Protect].**
- 7 Press the OK button.**  
The selected image or sound file is protected.

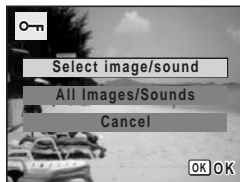

- To cancel the Protect setting, select [Unprotect] in Step 6.
- [ ] appears below the file number on protected images and sound files during playback.



## Editing Images

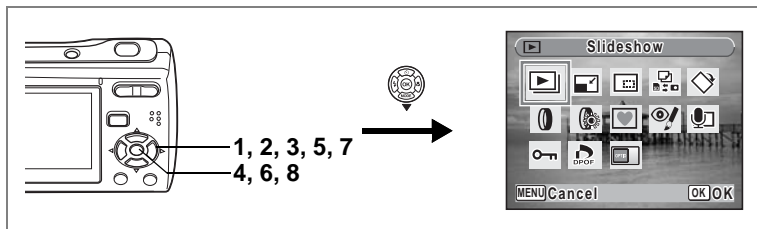

## Changing the Image Size and Quality (Resize)

By changing the size and quality of a selected image, you can make the file size smaller than the original. You can use this function to continue taking pictures when the SD Memory Card or built-in memory is full, by making the images smaller and overwriting the original images to make more space available.



- You cannot resize panoramic pictures, images taken with the 16-frame shooting function and movies.
- You cannot select a larger resolution or higher quality than that of the original image.
- You can resize the images to **7M**, **6M**, or **320**, in addition to the regular recorded pixels for still pictures (p.61).

- 1 Enter the mode and use the four-way controller ( ) to choose the image you want to resize.**
- 2 Press the four-way controller (.**  
The Playback Mode Palette appears.
- 3 Use the four-way controller ( ) to select (Resize).**
- 4 Press the OK button.**

The screen for choosing the size and quality appears.



## 5 Select [Recorded Pixels] and [Quality Level].

Use the four-way controller (◀▶) to choose the size and quality.

Use the four-way controller (▲▼) to switch between [Recorded Pixels] and [Quality Level].

## 6 Press the OK button.

A confirmation dialog for overwriting the image appears.

If the image is protected, a confirmation screen does not appear. The image is automatically saved with a new file name.

## 7 Use the four-way controller (▲▼) to select [Overwrite] or [Save as].

## 8 Press the OK button.



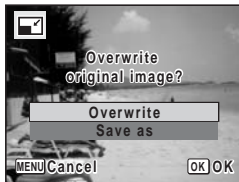

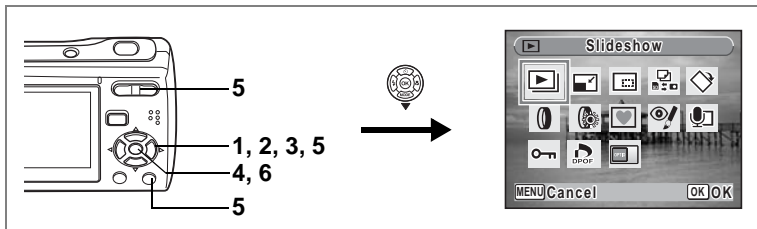



The resized image is saved.









## Cropping Images

You can delete the unwanted part of a picture and save the cropped image as a new image.

- 1 Enter the  mode and use the four-way controller ( ) to choose the image you want to crop.**
- 2 Press the four-way controller ().**  
The Playback Mode Palette appears.
- 3 Use the four-way controller (   ) to select  (Cropping).**
- 4 Press the OK button.**  
The Cropping screen appears.
- 5 Specify the portion to be cropped.**

Zoom button      Changes the size of the portion to be cropped

Four-way controller (   )  
Moves the cropping frame

Green button      Rotates the cropping frame

- 6 Press the OK button.**

The cropped image is saved with a new file name.

The cropped image is saved in the same quality level as the original image. The number of recorded pixels is selected automatically according to the size of the cropped section.

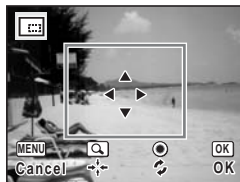

Panoramic pictures, images taken with the 16-frame shooting function, and movies cannot be cropped.

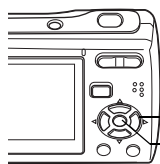

1, 2, 4, 6  
3, 5, 7



## Copying Images and Sound Files

You can copy images and sound files from the built-in memory to the SD Memory Card and vice versa. This function can only be selected when an SD Memory Card has been inserted in the camera.



Make sure that the camera is turned off before inserting or removing the SD Memory Card.

- 1 Press the four-way controller (▼) in mode.**  
The Playback Mode Palette appears.
- 2 Use the four-way controller (▲▼◀▶) to select .**  
(Image/Sound Copy).
- 3 Press the OK button.**  
The copying method selection screen appears.

### Copying Files from the Built-in Memory to the SD Memory Card

All the images and sound files in the built-in memory are copied to the SD Memory Card at once. Before copying the images, make sure that there is enough space in the SD Memory Card.

- 4 Use the four-way controller (▲▼) to select [ → SD].**
- 5 Press the OK button.**  
All the images and sound files are copied.





## Copying Files from the SD Memory Card to the Built-in Memory

Selected images and sound files from the SD Memory Card are copied to the built-in memory one at a time.

**4** Use the four-way controller (▲▼) to select [SD] → [●].

**5** Press the OK button.

**6** Use the four-way controller (◀▶) to select the file you want to copy.

**7** Press the OK button.



The selected image/sound file is copied.



- If sound has been recorded with the image, the sound file is also copied with the image.
- When a file is copied from the SD Memory Card to the built-in memory, it is assigned a new file name.

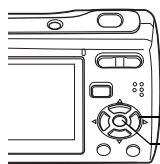













1, 2, 3, 5, 7  
4, 6, 8



## Using the Digital Filter

You can change the color tone of taken images or give them digital effect without a PC. Select a digital filter from B&W, Sepia, Red, Pink, Purple, Blue, Green, Yellow, Tile, and Soft to arrange the images in your style.

- 1 Enter the  mode and use the four-way controller ( ) to choose the image you want to edit.**
- 2 Press the four-way controller ().**  
The Playback Mode Palette appears.
- 3 Use the four-way controller (   ) to select  (Digital Filter).**
- 4 Press the OK button.**  
The digital filter selection screen appears.
- 5 Use the four-way controller ( ) to choose a digital filter.**  
The preview of the edited image is displayed on the LCD monitor. It changes each time you switch the filter.
- 6 Press the OK button.**  
A confirmation dialog for overwriting the image appears.
- 7 Use the four-way controller ( ) to select [Overwrite] or [Save as].**  
If the image is protected, a confirmation screen does not appear. The image is automatically saved with a new file name.
- 8 Press the OK button.**  
The edited image is saved with the same number of recorded pixels and quality level as the original.

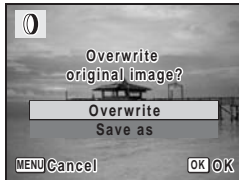



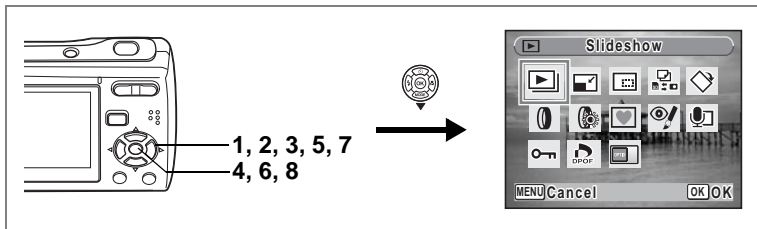









With the digital filter, you can edit still pictures taken with this camera only. You cannot edit panoramic pictures, movies, or images taken with other cameras.



## Using the Brightness Filter

You can change the brightness of taken images without a PC.

- 1 Enter the  mode and use the four-way controller ( ) to choose the image you want to edit.**
- 2 Press the four-way controller ().**  
The Playback Mode Palette appears.
- 3 Use the four-way controller (   ) to select .**
- 4 Press the OK button.**  
The brightness adjustment screen appears.
- 5 Use the four-way controller ( ) to adjust the brightness.**  
The preview of the edited image is displayed on the LCD monitor. It changes each time you adjust the brightness.
- 6 Press the OK button.**  
A confirmation dialog for overwriting the image appears.
- 7 Use the four-way controller ( ) to select [Overwrite] or [Save as].**  
If the image is protected, a confirmation screen does not appear. The image is automatically saved with a new file name.
- 8 Press the OK button.**  
The edited image is saved with the same number of recorded pixels and quality level as the original.





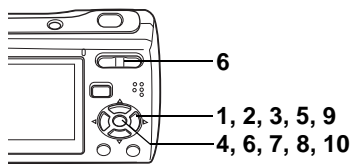

With the brightness filter, you can edit still pictures taken with this camera only. You cannot edit panoramic pictures, movies, or images taken with other cameras.



## Adding a Frame (Frame Composite)

You can add a frame to taken pictures. You can use the frames stored in your camera, and new frames downloaded from websites.





- 1 Enter the  mode and use the four-way controller ( ) to choose the image to which you want to add a frame.**
- 2 Press the four-way controller ().**

The Playback Mode Palette appears.

- 3 Use the four-way controller (   ) to select  (Frame Composite).**

- 4 Press the OK button.**

A nine-frame display of frames stored in your camera appears on the LCD monitor.

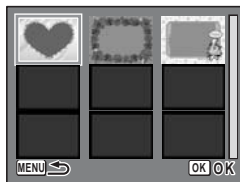

- 5 Use the four-way controller (   ) to choose a frame.**



- 6 Press the OK button or  on the Zoom button.**

The selected frame appears in single-image display.

You can choose another frame using either of the following operations.

Four-way controller ( ) : displays another frame

**MENU** button or Zoom button ()

: returns to the nine-frame display of available frames



## 7 Press the OK button.

The frame position and size adjustment screen appears. Use the four-way controller (▲▼◀▶) to adjust the position of the image, and use the Zoom button to enlarge or diminish the image.

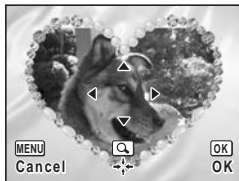

## 8 Press the OK button.

A confirmation dialog for overwriting the image appears.

## 9 Use the four-way controller (▲▼) to select [Overwrite] or [Save as].

If the image is protected, a confirmation screen does not appear. The image is automatically saved with a new file name.



## 10 Press the OK button.

The edited image is saved with the recorded pixels of **3M**.



The Frame Composite function cannot be used on panoramic pictures, images taken with the 16-frame shooting function, movies, and images of size **2M** or smaller. An error message appears in Step 4.

### Using a New Frame

Frames downloaded from a website or other source can be used when taking pictures. To display available frames stored in the built-in memory or the SD Memory Card, in Step 3, select  (Frame Composite) and press the **OK** button.



- The three frames stored in the built-in memory cannot be deleted.
- Up to 96 downloaded frames can be displayed. Including the three frames already stored in the built-in memory, you can choose from up to 99 frames.

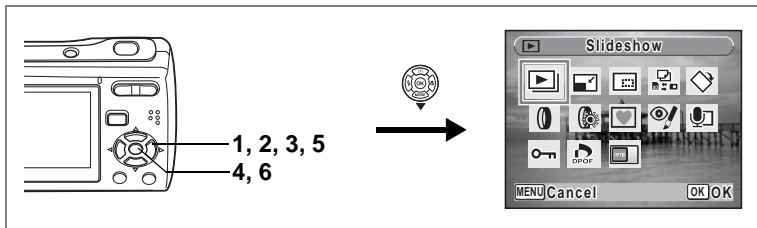

## Red-eye Compensation

You can compensate the “red-eye” in flash pictures.

- 1** Enter the mode and use the four-way controller (◀▶) to choose the image you want to correct.
- 2** Press the four-way controller (▼).  
The Playback Mode Palette appears.
- 3** Use the four-way controller (▲▼◀▶) to select (Red-eye Compensation).
- 4** Press the OK button.  
A confirmation dialog for overwriting the image appears.
- 5** Use the four-way controller (▲▼) to select [Overwrite] or [Save as].  
If the image is protected, a confirmation screen does not appear. The image is automatically saved with a new file name.
- 6** Press the OK button.



The edited image is saved with the same number of recorded pixels and quality level as the original.



- The red-eye compensation function cannot be used on movies or on images where red eyes cannot be detected on the camera. An error message appears in Step 4.
- The red-eye compensation can be used for still images taken with this camera. However, it cannot be used for images taken with the 16-frame shooting function.

# Setting the Printing Service (DPOF)

DPOF (Digital Print Order Format) is the format for storing print order data on still pictures captured with a digital camera. Once the print order data has been stored, the pictures can be printed according to the DPOF settings using a DPOF-compatible printer or photo processing lab. You cannot store print order data for movies or sound-only files.

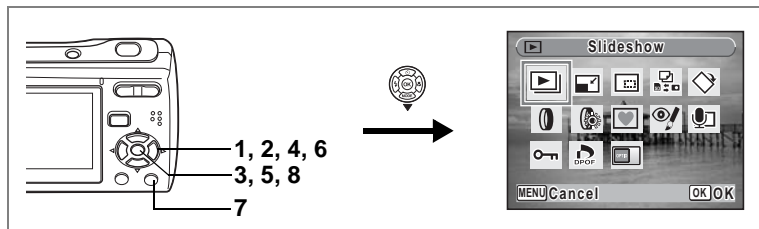

## Printing Single Images

Set the following items for each image.

Copies	Choose the number of copies up to 99.
Date	Specify whether you want the date inserted on the print or not.

- 1 Press the four-way controller (▼) in [▶] mode.**  
The Playback Mode Palette appears.
- 2 Use the four-way controller (▲▼◀▶) to select [DPOF].**
- 3 Press the OK button.**  
The screen for selecting [Single Image] or [All Images] appears.
- 4 Use the four-way controller (▲▼) to select [Single Image].**



## 5 Press the **OK** button.

The message [DPOF setting for this image] appears. To make DPOF settings for another image, use the four-way controller (◀▶) to select another image.

If DPOF settings have already been made for an image, the previous number of copies and date setting (☑ or ☐) will be displayed.

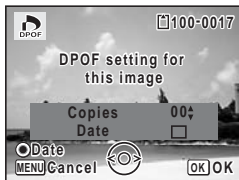

## 6 Use the four-way controller (▲▼) to choose the number of copies.

## 7 Use the Green button to choose whether to insert the date or not.

☑ (On) : The date will be imprinted.

☐ (Off) : The date will not be imprinted.

To continue setting DPOF print order data, use the four-way controller (◀▶) to choose another image and repeat Steps 6 and 7.



## 8 Press the **OK** button.

The DPOF settings are saved and the screen returns to the DPOF menu.



Depending on the printer or printing equipment at the photo processing lab, the date may not be imprinted on the pictures even if ☑ (On) was selected in the DPOF settings.



To cancel DPOF settings, set the number of copies to [00] in Step 6 and press the **OK** button.



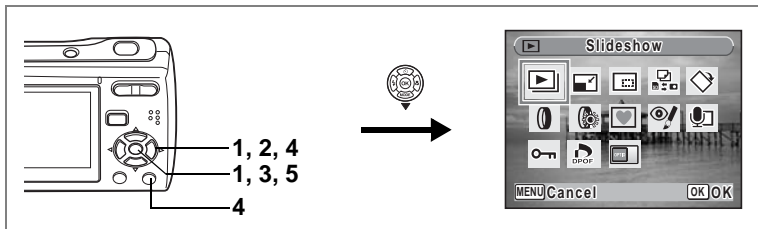

## Printing All Images

When you choose the number of copies and whether or not to insert the date, the settings are applied to all the images stored in the camera.

- 1 Display the screen for DPOF settings in mode.**  
Refer to Steps 1 to 3 on p.117.
- 2 Use the four-way controller ( ) to select [All Images].**

- 3 Press the OK button.**

The message [DPOF setting for all images] appears.

- 4 Choose the number of copies and whether to insert the date or not.**

Refer to Steps 6 and 7 in “Printing Single Images” (p.118) for details of how to make the settings.

- 5 Press the OK button.**

The DPOF settings for all the images are saved and the camera returns to the DPOF setting screen.

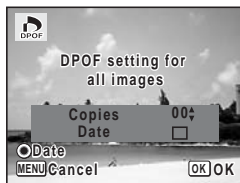

The number of copies specified in the DPOF settings applies to all the images. Before printing, check that the number is correct.



Settings for single images are canceled when settings are made for all images.

# Printing Using PictBridge

By connecting the camera to a printer that supports PictBridge using the supplied USB/AV cable (I-UAV62), you can print images directly from the camera without using a PC. Connect the camera to the printer and select the images you want to print and the number of copies on the camera.



- You are recommended to use the AC adapter kit K-AC62 when the camera is connected to the printer. The printer may not work properly or the image data may be lost if the battery runs out of power while the camera is connected to the printer.
- Do not disconnect the USB/AV cable during data transfer.
- Depending on the type of printer, not all the settings made on the camera (such as print settings and DPOF settings) may be valid.
- A printing error may occur if the selected number of copies exceeds 500.
- Printing the index of the images (printing multiple images on a single sheet) cannot be performed directly from the camera. Make the settings on a printer supporting index printing function or use a PC.

6

## Connecting the Camera to the Printer

- 1 Select [PictBridge] for the [USB Connection] mode on the [X↓ Setting] menu.**

Refer to “Changing the USB Connection Mode” (p.138).

- 2 Turn off the camera.**

- 3 Connect the camera to the printer using the supplied USB/AV cable.**

- 4 Turn the printer on.**

- 5 When the printer is ready to print, turn the camera on.**

The printing mode selection screen appears.

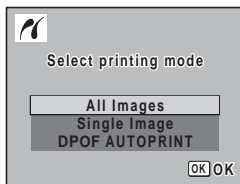

## Printing Single Images

- 1 In the printing mode selection screen, use the four-way controller (▲▼) to select [Single Image].**
- 2 Press the OK button.**  
The setting screen appears.
- 3 Use the four-way controller (◀▶) to choose an image to print.**
- 4 Use the four-way controller (▲▼) to choose the number of copies.**  
You can print up to 99 copies.
- 5 Use the Green button to choose whether to insert the date or not.**  
 (On) : The date will be imprinted.  
 (Off) : The date will not be imprinted.
- 6 Press the OK button.**  
A confirmation dialog appears.  
To print the pictures according to the print settings on the printer, press the **OK** button.  
To change the print settings, go to Step 7.
- 7 Press the Green button.**  
The screen for changing the print settings appears.
- 8 Select [Paper Size] and press the four-way controller (▶).**

The Paper Size screen appears.

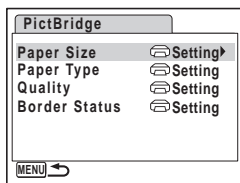
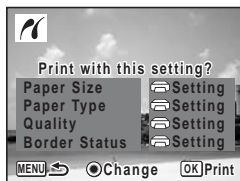
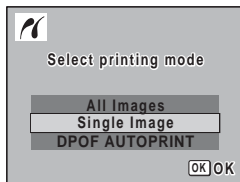

## 9 Use the four-way controller (▲▼◀▶) to choose the paper size.

You can only choose a size that is supported by your printer.

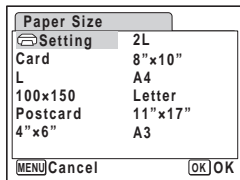

## 10 Press the OK button.

The Paper Size setting is saved, and the screen returns to the print settings screen.

## 11 Use the four-way controller (▲▼) to select [Paper Type] and press the four-way controller (▶).

A pull-down menu appears.

## 12 Use the four-way controller (▲▼) to select the paper type and press the OK button.

The Paper Type setting is saved, and the screen returns to the print settings screen. Set [Quality] and [Border Status] in the same way as in Steps 11 and 12.

If you select [Setting] for each print setting, images are printed according to the settings made on the printer.

Paper Type with more ★ supports higher quality paper.

Quality with more ★ indicates higher print quality.

The print settings screen appears after each item has been set.

## 13 Press the MENU button.

The screen returns to the confirmation dialog.

## 14 Press the OK button.

The image is printed according to the settings.

Press the **MENU** button to cancel printing.



- The power lamp lights while the camera is communicating with the printer, and blinks while the card is being accessed and during printing. Do not disconnect the USB/AV cable while the power lamp is blinking.
- The [Paper Size], [Paper Type], [Quality] and [Border Status] settings are reset to the defaults when the camera is turned off.

Disconnecting the Cable from the Printer p.124

## Printing All Images

- 1 In the printing mode selection screen, use the four-way controller (▲ ▼) to select [All Images].**

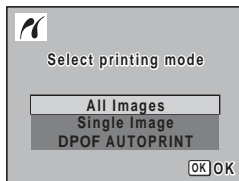

- 2 Press the OK button.**

The setting screen appears.

- 3 Choose the number of copies and whether to insert the date or not.**

The number of copies and date setting that you choose apply to all the images.

Refer to Steps 4 and 5 in “Printing Single Images” (p.121) for details of how to make the settings.

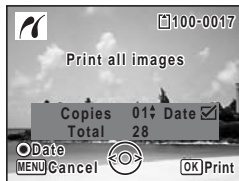

- 4 Press the OK button.**

A confirmation dialog appears.

Refer to Steps 7 to 11 of “Printing Single Images” (p.121, p.122) for details of changing print settings.

- 5 Press the OK button on the print settings confirmation screen.**

All the images are printed according to the settings.

Press the **MENU** button to cancel printing.

## Printing Using the DPOF Settings

**1** In the printing mode selection screen, use the four-way controller (▲▼) to select [DPOF AUTOPRINT].

**2** Press the OK button.

The DPOF settings you have made appear. Use the four-way controller (◀▶) to check the number of copies for each picture, whether to insert the date or not, and the total number of copies. Refer to p.117 for instructions on how to make the DPOF settings.

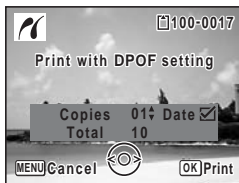

**3** Press the OK button.

A confirmation dialog appears.

Refer to Steps 7 to 11 of “Printing Single Images” (p.121, p.122) for details of changing print settings.

**4** Press the OK button on the print settings confirmation screen.

The images are printed according to the settings.

Press the **MENU** button to cancel printing.

6

## Disconnecting the Cable from the Printer

Disconnect the USB/AV cable from the camera and the printer when you finish printing.

**1** Turn off the camera.

**2** Disconnect the USB/AV cable from the camera and the printer.

## Printing Using ImageLink

This camera is compatible with the ImageLink print system. Instead of using a USB/AV cable, connect the supplied O-DI69 dock insert and Kodak EasyShare Printer Dock and place the camera on the dock insert to connect the camera to the printer dock. You can print images by simply pressing a button on the printer dock.

Refer to the Operating Manual that came with your printer dock for information on how to print images and other details.



- Some printer functions may not work when using the camera with a printer dock.
- The camera cannot be connected to another printer or PC via USB/AV cable while connected to the printer dock.

## Recording Sound (Voice Recording Mode)

You can record sound with the camera. The microphone is located below and to the left of the lens on the camera. When recording sound, aim the camera to obtain the best conditions.

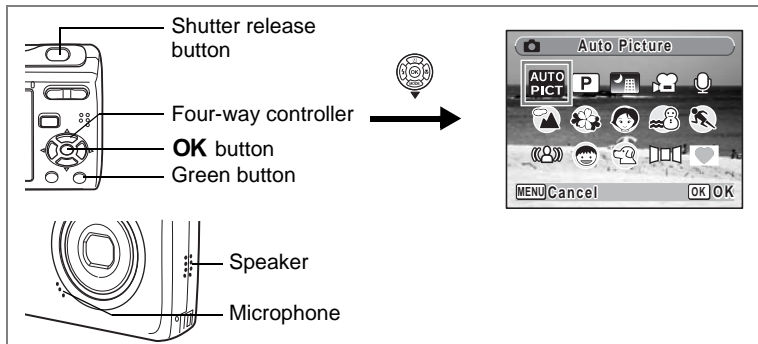

- 1 Press the four-way controller (▼) in mode.**  
The Capture Mode Palette appears.
- 2 Use the four-way controller (▲▼◀▶) to select (Voice Recording).**
- 3 Press the OK button.**

The remaining recordable time and the recording time of the current file appear on the LCD monitor.

- 1 Recording time
- 2 Remaining recordable time

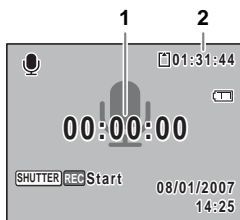

- 4 Press the shutter release button fully.**  
Recording starts. The self-timer lamp blinks during recording.  
You can record sound continuously until the built-in memory/SD Memory Card reaches full, or for max. 24 hours.





When the Green button is pressed during recording, an index can be added to the current sound file.

## 5 **Press the shutter release button fully.**

Recording stops.





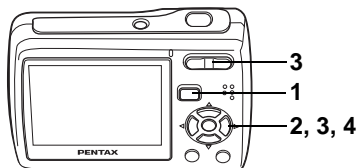

- If you press and hold down the shutter release button for more than one second in Step 4, recording continues until you take your finger off the button.
- Sound is saved in WAVE monaural files.

# Playing Back Sound

You can play back the sound files you made in  mode.





- 1** Press the  button.
- 2** Use the four-way controller ( ) to choose a sound file to play back.
- 3** Press the four-way controller ().

The sound file is played back.

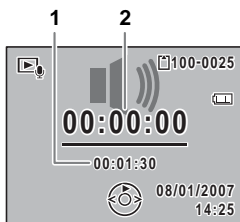
- 1 Total file recording time
- 2 Playback time





**The following operations can be performed during playback.**

- Four-way controller () Pauses playback
- Zoom button () Increases the volume
- Zoom button () Reduces the volume



If there are no recorded indexes:

- Four-way controller () Reverses playback
- Four-way controller () Fast forwards playback

If there are recorded indexes:

- Four-way controller () Plays back starting from the previous index
- Four-way controller () Plays back starting from the next index

**The following operations can be performed while playback is paused.**

- Four-way controller () Resumes playback
- Four-way controller () Rewinds approx. 5 seconds
- Four-way controller () Advances approx. 5 seconds

- 4** Press the four-way controller ().







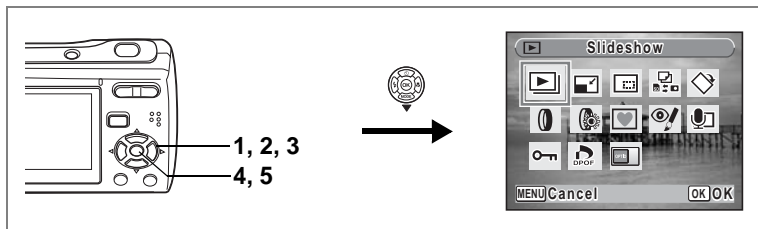

Playback stops.

# Adding a Voice Memo to Images

You can add a voice memo to your still pictures.



## Recording a Voice Memo



- 1 Enter the  mode and use the four-way controller ( ) to choose the still picture to which you want to add a voice memo.**
- 2 Press the four-way controller ().**  
The Playback Mode Palette appears.
- 3 Use the four-way controller (   ) to select  (Voice Memo).**
- 4 Press the OK button.**  
Recording starts. You can record a voice memo until the built-in memory/SD Memory Card reaches full, or up to 24 hours consecutively.
- 5 Press the OK button.**  
Recording stops.

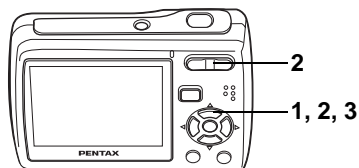

- A voice memo cannot be added to an image that already has a voice memo. Delete the old voice memo and record a new one. (p.101)
- A voice memo cannot be added to panoramic pictures, images taken with the 16-frame shooting function, and protected () images (p.105).



## Playing Back a Voice Memo



- 1 Enter the  mode and use the four-way controller ( ) to choose the still picture with the voice memo that you want to play back.**

 appears on images with voice memos in single-image display.



- 2 Press the four-way controller ()**.  
Playback starts.

The following operations can be performed during playback.

- Zoom button () Increases the volume
- Zoom button () Reduces the volume

- 3 Press the four-way controller ()**.  
Playback stops.

Deleting a Sound File  p.101

## Camera Settings

How to display the [X Setting] menu

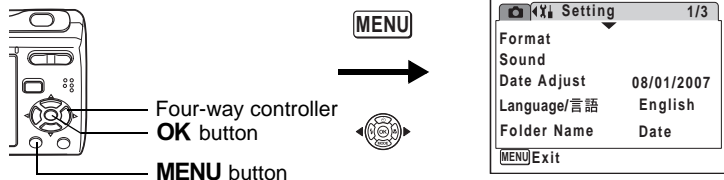

## Formatting an SD Memory Card or the Built-in Memory

Formatting will delete all the data on the SD Memory Card. All the data in the built-in memory will be deleted if no SD Memory Card is inserted in the camera.

### Caution

- Do not remove the SD Memory Card during formatting as this may damage the card and render it unusable.
- Formatting will delete protected images and any data recorded on the card with a camera other than this camera.
- SD Memory Cards formatted on a PC or device other than the camera cannot be used. Be sure to format the card with the camera.

- 1 Use the four-way controller (▲▼) to select [Format] on the [X Setting] menu.**
- 2 Press the four-way controller (▶).**  
The Format screen appears.
- 3 Use the four-way controller (▲▼) to select [Format].**
- 4 Press the OK button.**

Formatting starts. When formatting is completed, the camera returns to Capture mode or Playback mode.

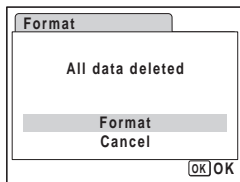

How to display the [X Setting] menu

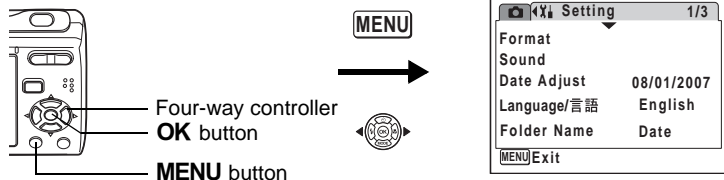

## Changing the Sound Settings

You can adjust the volume of operation sounds and change the type of sound.

- 1 Use the four-way controller (▲▼) to select [Sound] on the [X Setting] menu.
- 2 Press the four-way controller (▶).  
The Sound screen appears.

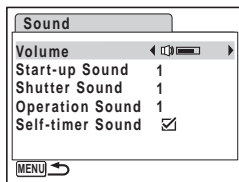

## Changing the Operation Volume

- 3 Use the four-way controller (▲▼) to select [Volume].
- 4 Use the four-way controller (◀▶) to adjust the volume.  
The selected volume is saved.  
Set the volume to 0 to mute the start-up sound, shutter sound, operation sound, and self-timer sound.

## Changing the Sound Type

- 5 Use the four-way controller (▲▼) to select [Start-up Sound].
- 6 Press the four-way controller (▶).  
A pull-down menu appears.

- 7 Use the four-way controller (▲ ▼) to select [1], [2], [3] or [Off] and press OK button.**

The selected sound type is saved.

- 8 Set [Shutter Sound] and [Operation Sound] in the same way as in Steps 5 to 7.**

Use the four-way controller (◀ ▶) to select  (On) or  (Off) for the self-timer sound.

- 9 Press the MENU button.**

The screen returns to the [X↓ Setting] menu with the changed setting.

How to display the [X Setting] menu

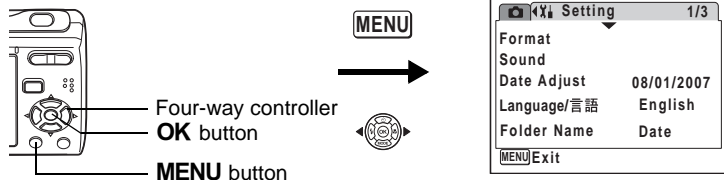

## Changing the Date and Time

You can change the initial date and time settings. You can also set the style in which the date appears on the camera.

- 1 Use the four-way controller (▲▼) to select [Date Adjust] on the [X Setting] menu.**
- 2 Press the four-way controller (▶).**  
The Date Adjust screen appears.

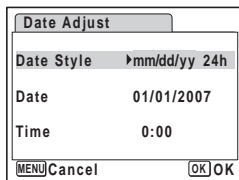

- 3 Press the four-way controller (▶).**  
The frame moves to [mm/dd/yy].  
Depending on the initial setting or previous setting, [dd/mm/yy] or [yy/mm/dd] may be displayed.

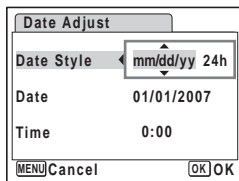

- 4 Use the four-way controller (▲▼) to choose the date display style.**  
Choose [mm/dd/yy], [dd/mm/yy] or [yy/mm/dd].
- 5 Press the four-way controller (▶).**  
The frame moves to [24h].

- 6 Use the four-way controller (▲▼) to select [24h] (24-hour display) or [12h] (12-hour display).**

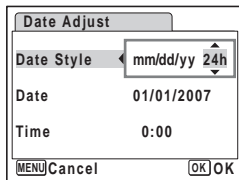



## 7 Press the four-way controller (▶).

The frame returns to [Date Style].

## 8 Press the four-way controller (▼).

The frame moves to [Date].

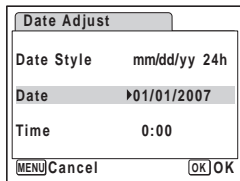

## 9 Press the four-way controller (▶).

The frame moves to one of the following items depending on the date style set in Step 4.

For [mm/dd/yy] month (Example: [01])

For [dd/mm/yy] day (Example: [01])

For [yy/mm/dd] year (Example: [2007])

The following operations and screens use [mm/dd/yy] as an example. The operations are the same even if another date style has been selected.

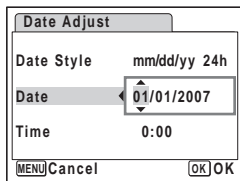

## 10 Use the four-way controller (▲▼) to change the month.

## 11 Press the four-way controller (▶).

The frame moves to the day field. Use the four-way controller (▲▼) to change the day. After changing the day, change the year in the same manner.

## 12 Change the time in the same way as in Steps 7 to 10.

If you selected [12h] in Step 6, the setting switches between am and pm corresponding to the time.

## 13 Press the OK button.

The date and time settings are saved.



When you finish the settings and press the **OK** button, the camera clock is reset to 00 seconds. To set the exact time, press the **OK** button when the time signal (on the TV, radio, etc.) reaches 00 seconds.

How to display the [X↓ Setting] menu

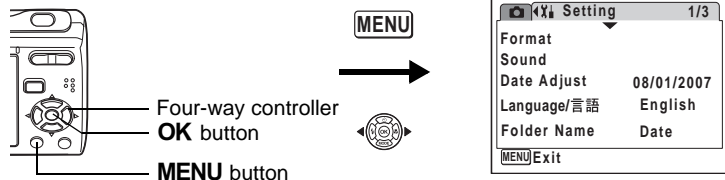

## Changing the Display Language

You can change the language in which the menus, error messages, etc. are displayed.

You can choose from English, French, German, Spanish, Portuguese, Italian, Dutch, Danish, Swedish, Finnish, Polish, Czech, Hungarian, Turkish, Russian, Thai, Korean, Chinese (traditional and simplified) and Japanese.

- 1 Use the four-way controller (▲▼) to select [Language/言語] on the [X↓ Setting] menu.**
- 2 Press the four-way controller (▶).**  
The Language/言語 screen appears.
- 3 Use the four-way controller (▲▼◀▶) to select the language.**
- 4 Press the OK button.**



How to display the [X Setting] menu

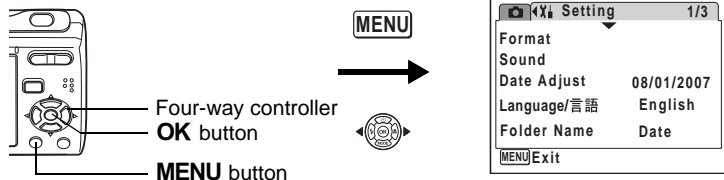

## Changing the Image Folder Name

You can change the image folder name from the standard name or the date that pictures were taken. When [Date] is selected, pictures are saved in separate folders by the date they were taken.

### Folder Name

Standard	XXXXPENTX (where XXX is the 3-digit folder number)
Date	XXX_mmdd (3-digit folder number_month day) * xxx_ddmm (3-digit folder number_day month) when the date style is set to [dd/mm/yy].

Picture taken with standard folder name (Example: March 25)

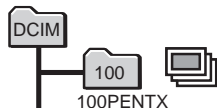

Folder name changed to date setting (Example: March 25)

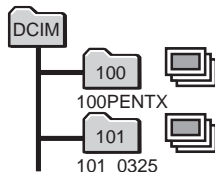

Next time a picture is taken (Example: April 1)

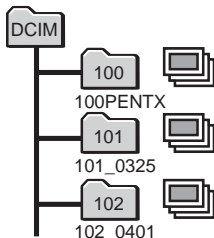

- 1 Use the four-way controller (▲ ▼) to select [Folder Name] on the [X Setting] menu.
- 2 Press the four-way controller (▶).  
A pull-down menu appears.
- 3 Use the four-way controller (▲ ▼) to select [Standard] or [Date].
- 4 Press the OK button.  
The Folder Name setting is saved.



The capacity of an image folder is 999 files maximum. When the number of files reaches 999, a new folder will be automatically created.

How to display the [X Setting] menu

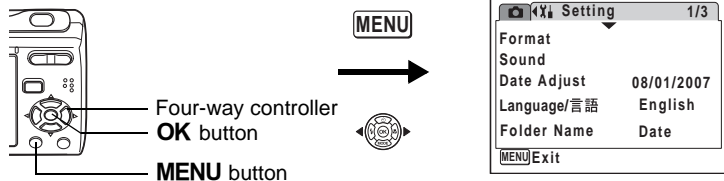

## Changing the USB Connection Mode

Choose the appropriate USB connection mode depending on whether you are going to connect the USB/AV cable to a PC or a PictBridge-compatible printer.



For instructions on connecting the camera to a computer, refer to the PC Connection Manual contained in the CD-ROM that contains this Operating Manual.

- 1 Use the four-way controller (▲▼) to select [USB Connection] on the [X Setting] menu.
  - 2 Press the four-way controller (▶).
- A pull-down menu appears.
- 3 Use the four-way controller (▲▼) to select [PC] or [PictBridge].

[PC] : Select this option when transferring image data to a computer

[PictBridge] : Select this option when connecting the camera to a PictBridge-compatible printer

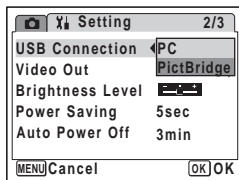

- 4 Press the OK button.

The USB Connection setting is saved.



Do not connect the camera to your PC while [PictBridge] is selected for the USB Connection mode. And do not connect the camera to your printer while [PC] is selected.

How to display the [X Setting] menu

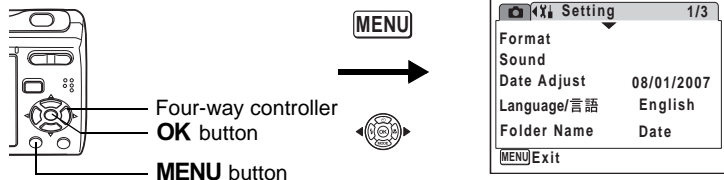

## Changing the Video Output Format

When you connect the camera to AV equipment, choose the appropriate video output format (NTSC or PAL) for taking and playing back images.

- 1 Use the four-way controller (▲▼) to select [Video Out] on the [X Setting] menu.**
- 2 Press the four-way controller (▶).**  
A pull-down menu appears.
- 3 Use the four-way controller (▲▼) to select [NTSC] or [PAL].**  
Choose the video output format to match the output format of the AV equipment.
- 4 Press the OK button.**  
The Video Out setting is saved.

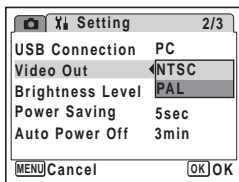

Depending on the country or region, images and sound files may fail to be played back if the video output format is set different from the one in use there. If this happens, change the video output format setting.

Playing Back Images on a TV p.99

How to display the [X Setting] menu

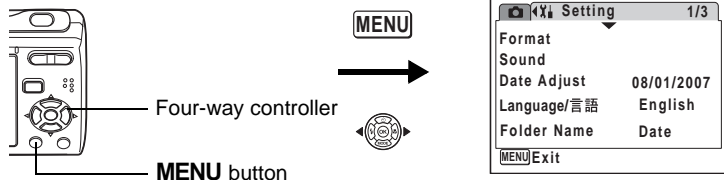

## Adjusting the Brightness of the LCD Monitor

You can adjust the brightness of the LCD monitor for easy viewing. It is useful when you view the LCD monitor outdoors or in brighter places.

- 1 Use the four-way controller (▲▼) to select [Brightness Level] on the [X Setting] menu.
- 2 Use the four-way controller (◀▶) to adjust the brightness.

The following setting is saved.

■ — + (Dark)

— ■ + (Normal)

— ■ + (Bright)

- 3 Press the MENU button.

The camera returns to Capture mode or Playback mode.

The LCD monitor is displayed with the set brightness.

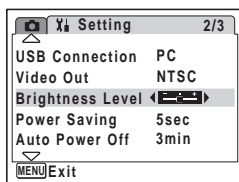

## How to display the [X Setting] menu

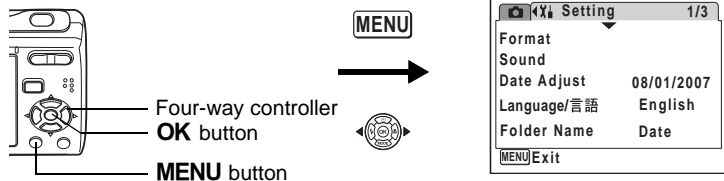

## Using the Power Saving Function

You can save battery power by setting the LCD monitor to turn off automatically when no operation is performed for a fixed time. After the power saving function has been activated, you can turn the LCD monitor on again by pressing any of the buttons.

- 1 Use the four-way controller (▲▼) to select [Power Saving] on the [X Setting] menu.**
- 2 Press the four-way controller (▶).**  
A pull-down menu appears.
- 3 Use the four-way controller (▲▼) to select [2min], [1min], [30sec], [15sec], [5sec] or [Off].**
- 4 Press the OK button.**

The Power Saving setting is saved.

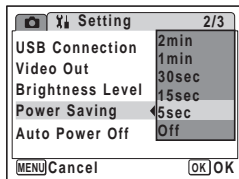

How to display the [X Setting] menu

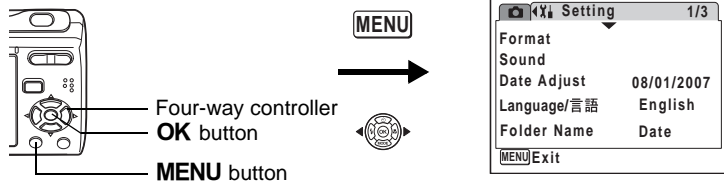

## Setting Auto Power Off

You can set the camera to turn off automatically when no operation is performed for a fixed time.

- 1 Use the four-way controller (▲▼) to select [Auto Power Off] on the [X Setting] menu.**
- 2 Press the four-way controller (▶).**  
A pull-down menu appears.
- 3 Use the four-way controller (▲▼) to select [5min], [3min] or [Off].**
- 4 Press the OK button.**  
The Auto Power Off setting is saved.

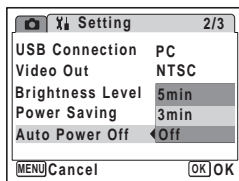

Auto Power Off does not function while the camera is connected to a PC or a printer.



## How to display the [X Setting] menu

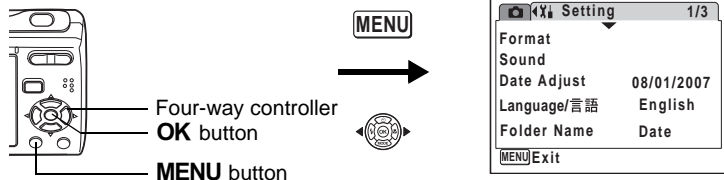

## Setting the Guide Display

You can set to display or hide guides when the mode is selected in Capture Mode Palette (p.45) and Playback Mode Palette (p.47).

- 1 Use the four-way controller (▲▼) to select [Guide Display] on the [X Setting] menu.**
- 2 Use the four-way controller (◀▶) to select  (On) or  (Off).**

The following setting is saved.

On : Display

Off : Hide

- 3 Press the MENU button.**

The camera returns to Capture mode or Playback mode.

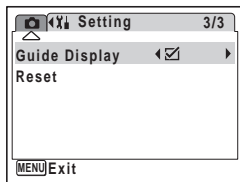

How to display the [X Setting] menu

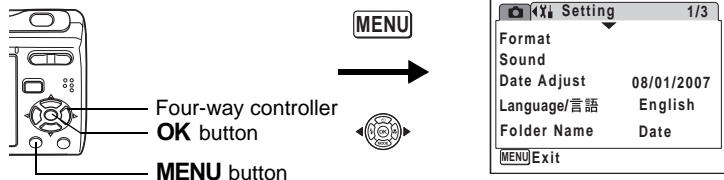

## Resetting to Default Settings (Reset)

You can reset the camera settings to their defaults. Refer to “Default Settings” (p.146) for the reset settings.

- 1 Use the four-way controller (▲▼) to select [Reset] on the [X Setting] menu.**
- 2 Press the four-way controller (▶).**  
The Reset screen appears.
- 3 Use the four-way controller (▲▼) to select [Reset].**
- 4 Press the OK button.**  
The settings return to the defaults.

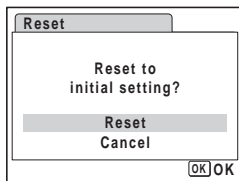

8

Settings







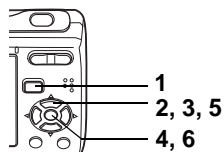





The settings on [Date Adjust], [Language/言語] and [Video Out] cannot be reset.

## How to display the Playback Mode Palette



## Changing the Start-up Screen

You can choose an image to be displayed as the start-up screen when the camera is turned on.

- 1 Press the  button.**  
The camera enters  mode.
- 2 Press the four-way controller ().**  
The Playback Mode Palette appears.
- 3 Use the four-way controller (   ) to select .**  
(Start-up Screen).
- 4 Press the OK button.**  
The image selection screen appears.
- 5 Use the four-way controller ( ) to choose an image for the start-up screen.**
- 6 Press the OK button.**  
The Start-up Screen setting is saved.



- Once the start-up screen has been set, it will not be deleted even if the original image is deleted or the SD Memory Card or built-in memory is formatted.
- Select [Off] to hide the start-up screen.
- You cannot use panoramic pictures and images taken with the 16-frame shooting function for the start-up screen.

# Default Settings

The table below lists the factory default settings.

The meaning of the indications for menu items with a default setting is explained below.

## Last Memory Setting

Yes : The current setting (last memory) is saved when the camera is turned off.

No : The setting returns to the default setting when the camera is turned off.

\* : The setting depends on the [Memory] setting (p.85).

— : NA

## Reset Setting

Yes : The setting returns to the default setting with the Reset function (p.144).

No : The setting is saved even after reset.

## ● [📷 Rec. Mode] Menu Items

Item		Default Setting	Last Memory Setting	Reset Setting	Page
Recorded Pixels		(3264x2448)	Yes	Yes	p.61
Quality Level		★★ (Better)	Yes	Yes	p.63
White Balance		<b>AWB</b> (Auto)	*	Yes	p.74
AF Mode		[ ] (Multiple)	Yes	Yes	p.70
Sensitivity		Auto	*	Yes	p.73
EV Compensation		±0.0	*	Yes	p.76
Movie	Recorded Pixels	(640x480)	Yes	Yes	p.89
	Frame Rate	30fps	Yes	Yes	p.90
	Color Mode	Full Color	Yes	Yes	p.91
Digital Zoom		<input checked="" type="checkbox"/> (On)	*	Yes	p.66
Instant Review		2 sec	Yes	Yes	p.84
Memory	Flash Mode	<input checked="" type="checkbox"/> (On)	*	Yes	p.71
	Drive Mode	<input type="checkbox"/> (Off)	*	Yes	p.80, p.81
	Focus Mode	<input type="checkbox"/> (Off)	*	Yes	p.67
	Zoom Position	<input type="checkbox"/> (Off)	*	Yes	p.65

Item		Default Setting	Last Memory Setting	Reset Setting	Page
Memory	MF Position	<input type="checkbox"/> (Off)	*	Yes	p.68
	White Balance	<input type="checkbox"/> (Off)	*	Yes	p.74
	Sensitivity	<input type="checkbox"/> (Off)	*	Yes	p.73
	EV Compensation	<input type="checkbox"/> (Off)	*	Yes	p.76
	Digital Zoom	<input checked="" type="checkbox"/> (On)	*	Yes	p.66
	DISPLAY	<input type="checkbox"/> (Off)	*	Yes	p.78, p.92
	File No.	<input checked="" type="checkbox"/> (On)	*	Yes	—
Sharpness		(Standard)	Yes	Yes	p.77
Saturation		(Standard)	Yes	Yes	p.77
Contrast		(Standard)	Yes	Yes	p.77
Date Imprint		<input type="checkbox"/> (Off)	Yes	Yes	p.83













### ● [M Setting] Menu Items

Item		Default Setting	Last Memory Setting	Reset Setting	Page
Sound	Volume	3	Yes	Yes	p.132
	Start-up Sound	1	Yes	Yes	
	Shutter Sound	1	Yes	Yes	
	Operation Sound	1	Yes	Yes	
	Self-timer Sound	<input checked="" type="checkbox"/> (On)	Yes	Yes	
Date Adjust	Date Style (date)	According to initial setting	Yes	No	p.29
	Date Style (time)	According to initial setting	Yes	No	
	Date	According to initial setting	Yes	No	
	Time	According to initial setting	Yes	No	
Language/言語		According to initial setting	Yes	No	p.28
Folder Name		Date	Yes	Yes	p.137
USB Connection		PC	Yes	Yes	p.138
Video Out		According to initial setting	Yes	No	p.139
Brightness Level		(Standard)	Yes	Yes	p.140
Power Saving		5 sec	Yes	Yes	p.141
Auto Power Off		3 min	Yes	Yes	p.142
Guide Display		<input checked="" type="checkbox"/> (On)	Yes	Yes	p.143

## ● Playback Mode Palette Items

Item		Default Setting	Last Memory Setting	Reset Setting	Page
Slideshow	Interval	3 sec	Yes	Yes	p.96
	Screen Effect	Wipe	Yes	Yes	
	Sound Effect	<input checked="" type="checkbox"/> (On)	Yes	Yes	
Start-up Screen		Optio Logo screen 1	Yes	Yes	p.145

## ● Key Operation

Item	Function	Default Setting	Last Memory Setting	Reset Setting	Page
 button	Operation Mode	 mode	—	—	—
Zoom/  /  /  button	Zoom Position	Wide	*	No	p.65
Four-way controller	 Drive Mode	<input type="checkbox"/> (Normal)	*	Yes	p.80, p.81
	 Shooting Mode	 (Auto Picture)	Yes	Yes	p.45
	 Flash Mode	 (Auto)	*	Yes	p.71
	 Focus Mode	<b>AF</b> (Standard)	*	Yes	p.67
<b>MENU</b> button	Menu Display	Capture mode: [  Rec. Mode] menu Playback mode: [  Setting] menu	—	—	p.40
<b>OK/DISPLAY</b> button	Information Display	Normal	*	Yes	p.78, p.92

# Functions Available for Each Shooting Mode

Yes: Can be set and function is available.

- : Fixed setting. Cannot be changed.

# : Can be set but function is not available.

No : Cannot be set.

(Auto)	Yes	Yes	Yes	No	No	No	Yes	Yes	Yes	Yes	Yes
(Flash Off)	Yes	Yes	Yes	Yes	-	No	Yes	Yes	Yes	Yes	Yes
(Flash On)	No	Yes	Yes	Yes	No	No	Yes	Yes	Yes	Yes	Yes
(Auto + Red-eye)	No	Yes	Yes	No	No	No	Yes	Yes	Yes	Yes	Yes
(Flash On + Red-eye)	No	Yes	Yes	Yes	No	No	Yes	Yes	Yes	Yes	Yes
(Self-timer)	Yes <sup>1</sup>	Yes	Yes	Yes	Yes	No	Yes	Yes	Yes <sup>8</sup>	Yes	Yes
(2 sec. Self-timer)	Yes <sup>1</sup>	Yes	Yes	Yes	Yes	No	Yes	Yes	Yes	Yes	Yes
(Continuous Shooting)	No	No	Yes	No	No	No	Yes	No	Yes <sup>7</sup>	Yes	Yes
(16-frame shooting)	No	No	Yes	No	No	No	No	No	Yes <sup>7</sup>	Yes	Yes
<b>AF</b> (Standard)	Yes	Yes	Yes	Yes	Yes	No	Yes	Yes	Yes	Yes	Yes
(Macro)	Yes	Yes	Yes	Yes	Yes	No	Yes	Yes	Yes	Yes	Yes
(Infinity)	No	Yes	Yes	Yes	Yes	No	Yes	Yes	Yes	Yes	Yes
<b>PF</b> (Pan Focus)	Yes	Yes	Yes	Yes	Yes	No	Yes	Yes	Yes	Yes	Yes
<b>MF</b> (Manual Focus)	No	Yes	Yes	Yes	Yes	No	Yes	Yes	Yes	Yes	Yes
Recorded Pixels	-	Yes	Yes	Yes	Yes <sup>2</sup>	#	Yes	-	Yes	Yes	Yes
Quality Level	-	Yes	Yes	Yes	Yes <sup>2</sup>	#	Yes	-	Yes	Yes	Yes
White Balance	-	-	Yes	Yes	Yes	#	-	-	-	-	-
AF Mode	-	-	Yes	Yes	Yes <sup>3</sup>	#	Yes	Yes <sup>3</sup>	Yes	Yes <sup>6</sup>	Yes
Sensitivity	-	Yes	Yes	Yes	-	#	- <sup>5</sup>	Yes	Yes	Yes	Yes
EV Compensation	No	No	Yes	Yes	Yes <sup>4</sup>	#	Yes	Yes	Yes	Yes	Yes
Movie	No	#	#	#	Yes	#	#	#	#	#	#
Digital Zoom	-	Yes	Yes	Yes	Yes	#	Yes	Yes	Yes	Yes	Yes
Instant Review	-	Yes	Yes	Yes	Yes	#	Yes	Yes	Yes	Yes	Yes
Memory	No	Yes	Yes	Yes	Yes	Yes	Yes	Yes	Yes	Yes	Yes
Sharpness	-	-	Yes	Yes	Yes	#	-	Yes	-	-	-
Saturation	-	-	Yes	Yes	Yes	#	-	Yes	-	-	-
Contrast	-	-	Yes	Yes	Yes	#	-	Yes	-	-	-
Date Imprint	No	Yes	Yes	Yes	No	No	Yes	Yes	Yes	Yes	Yes

\*1 The self-timer mode you have selected in a shooting mode other than Green Mode can be used.

\*2 Uses the settings in [Movie].

\*3 "Continuous" is not available.

\*4 Not available during recording

\*5 Fixed at an automatic high sensitivity setting

\*6 Uses either Face Recognition AF (when the camera recognizes the subject's face) or the setting in [AF Mode] (if the camera does not recognize the face).

\*7 In mode, "Continuous Shooting" and "16-frame shooting" are not available.

\*8 In mode, "10 sec. Self-timer" is not available.

# Optional Accessories

A number of dedicated accessories are available for this camera.

## **AC adapter kit K-AC62**

This kit includes the DC coupler D-DC51, the AC adapter D-AC62 and the AC plug cord.

## **USB/AV cable I-UAV62 (\*)**

### **Strap**

**O-ST62 (\*)**

**O-ST24** Genuine leather strap

**O-ST8** Silver chain strap

**O-ST30** Plastic coated strap

### **Camera case**

**O-CC58**

Products marked with an asterisk (\*) are the same as those supplied with the camera.



# Messages

Messages such as the following may appear on the LCD monitor during camera operation.

Battery depleted	The batteries are exhausted. Replace with new batteries. If using rechargeable batteries, charge the batteries. (p.18)
Built-in memory full	The built-in memory/SD Memory Card is full and no more images can be saved.
Memory card full	Insert a new SD Memory Card or delete unwanted images. (p.22, p.100) Change the quality level or recorded pixels of recorded images and try again. (p.107)
Memory card error	Shooting and playback are impossible due to a problem with the SD Memory Card. You may be able to display or copy the images on the card using a PC.
Card not formatted	The SD Memory Card you have inserted is unformatted or has been formatted on a computer or other device and is not compatible with this camera. (p.131)
Card locked	The SD Memory Card is write-protected. (p.24)
Compression error	This message appears when compression of images has failed. Change the quality level/size and record or save again.
No image/sound	There are no image/sound files on the SD Memory Card.
Deleting	This message appears when the camera is deleting an image or sound file.
Camera cannot play this image and sound	You are trying to play back an image or sound in a format not supported by this camera. You may be able to play it back on another brand of camera or your computer.
Image folder could not be created	The largest file number (9999) has been assigned to an image in the largest folder number (999) and no more images can be saved. Insert a new SD Memory Card or format the card. (p.131)
Protected	The image or sound file you are trying to delete is protected.
Data being recorded	This message appears when you try to switch to  mode while an image is still being recorded, or when the protect setting or DPOF setting is being changed. It disappears after the image is recorded or the setting is changed.
Data being processed	This message appears when the camera takes more than five seconds to display an image due to image processing, or when the SD Memory Card or built-in memory is being formatted.







Green mode must be canceled to use this function.	This function is not available in Green Mode. Press the Green button to cancel Green Mode. (p.48)
No image to be processed	This message appears when no image/sound file is present.
This image/sound cannot be processed	This message appears when you attempt to edit a file that cannot be processed.
No card in the camera	This message appears when you select [Image/Sound Copy] with no SD Memory Card inserted.
The card memory is not enough to copy images/sounds	This message appears when there is not enough memory on the SD Memory Card or in built-in memory to copy image/sound to. Insert a new SD Memory Card or delete unwanted images. (p.22, p.100)
The built-in memory is not enough to copy images/sounds	
Cannot process correctly	This message appears when Red-eye Compensation cannot be performed correctly.

Messages such as the following may appear on the LCD monitor when using the PictBridge function.

No paper in the printer	There is no paper in the printer.
No ink in the printer	There is no ink in the printer.
Printer error	An error message has been sent from the printer.
Data error	A data error message has been sent from the printer.
Paper stuck in the printer	The paper is stuck in the printer.

# Troubleshooting

Problem	Cause	Remedy
Camera will not turn on	Batteries are not installed	Check if the batteries are installed. If not, install the batteries.
	Batteries are installed incorrectly	Check orientation of the batteries. Reinsert the batteries according to the ⊕ ⊖ symbols on the batteries compartment. (p.18)
	Battery power is low	Insert new batteries or use the AC adapter.
No image on LCD monitor	Camera is connected to a PC	LCD monitor is off when camera is connected to a computer.
	Camera is connected to the AV equipment	LCD monitor is off when camera is connected to the AV equipment.
	Image is displayed but is hard to see	Image on LCD monitor may be hard to see when taking pictures outside in sunlight.
Shutter will not release	Flash is charging	Pictures cannot be taken while the flash is charging. Wait until charging is finished.
	No available space on SD Memory Card or in the built-in memory	Insert SD Memory Card with available space or delete unwanted images. (p.22, p.100)
	Recording	Wait until recording is finished.
	The number of image, movie, and sound files recorded on the SD Memory Card has reached 10000	Replace the SD Memory Card or delete unwanted images.
Picture is dark	Subject is too far away in a dark environment, such as a night scene	Picture becomes dark if subject is too far away. Take picture within range of flash.

Problem	Cause	Remedy
Subject is not in focus	Subject is difficult to focus on with auto focus	Try shooting using "Focus lock" (p.69), or "Manual Focus" (p.68).
	Subject is not in the focus frame	First, locate the subject in the focus frame and lock the focus on the subject (Focus lock). Then move the camera to recompose. (p.69)
Flash does not discharge	Flash mode is set to  (Flash Off)	Set to Auto or  (Flash On). (p.71)
	Drive mode is set to  or  Focus mode is set to  Shooting mode is set to 	Flash will not discharge in these modes.
USB connection with computer does not work properly	USB connection mode is set to [PictBridge]	Change the USB connection mode to [PC]. (p.138)
USB connection with printer does not work properly	USB connection mode is set to [PC]	Change the USB connection mode to [PictBridge]. (p.120)

Static electricity may occasionally prevent the camera from operating correctly. If this should occur, try removing and then reloading the batteries. If the camera turns on and operates properly, this indicates that there is no malfunction. You can use the camera as usual.

# Main Specifications

Type	Fully automatic compact digital still camera with built-in zoom lens	
Effective Pixels	8.1 megapixels	
Sensor	8.29 megapixels (total pixels) 1/2.5 inch interline transfer CCD with a primary color filter	
Recorded Pixels	Still Picture	8M (3264×2448 pixels), 5M (2592×1944 pixels) 4M (2304×1728 pixels), 3M (2048×1536 pixels) 2M (1600×1200 pixels), 1024 (1024×768 pixels) 640 (640×480 pixels) * Fixed at 3M (2048×1536) for Frame Composite
	Movie	640 (640×480 pixels), 320 (320×240 pixels)
Sensitivity	Auto, manual (ISO 80/160/320/400/800/1000) * Automatically adjusted between ISO 80 – 400 in ISO Auto. * In Digital SR mode, automatically adjusted to ISO 1000 (ISO Auto).	
File Format	Still Picture	JPEG (Exif 2.2), DCF, DPOF, PictBridge, PRINT Image Matching III
	Movie	AVI (Motion JPEG), streaming video, approx. 30fps/ 15fps, PCM system with monaural sound, full color/sepia/ black and white selectable
	Sound	Voice memo, voice recording: WAVE (PCM) system, monaural
Quality Level	Still Picture	★★★ "Best", ★★ "Better", ★ "Good"
Storage Medium	Built-in memory (approx. 10 MB), SD Memory Card, SDHC Memory Card	



## Approximate Image Storage Capacity and Recording Time

### Still Picture

	★★★ (Best)		★★ (Better)		★ (Good)	
	Built-in Memory	256MB	Built-in Memory	256MB	Built-in Memory	256MB
<b>8M</b> 3264×2448	2 pictures	62 pictures	4 pictures	121 pictures	7 pictures	187 pictures
<b>5M</b> 2592×1944	3 pictures	97 pictures	7 pictures	187 pictures	11 pictures	270 pictures
<b>4M</b> 2304×1728	4 pictures	121 pictures	10 pictures	243 pictures	14 pictures	348 pictures
<b>3M</b> 2048×1536	6 pictures	152 pictures	12 pictures	304 pictures	18 pictures	443 pictures
<b>2M</b> 1600×1200	10 pictures	243 pictures	17 pictures	406 pictures	25 pictures	609 pictures
<b>1024</b> 1024× 768	20 pictures	487 pictures	34 pictures	813 pictures	45 pictures	1060 pictures
<b>640</b> 640× 480	41 pictures	975 pictures	65 pictures	1524 pictures	87 pictures	2033 pictures

The image storage capacity is for reference only. The actual image storage capacity may vary depending on the SD Memory Card and the subject.

## Movie/Sound

		Movie (30fps)		Movie (15fps)		Sound	
		Built-in Memory	256MB	Built-in Memory	256MB	Built-in Memory	256MB
 640x480	★★★	11 sec.	4 min. 31 sec.	23 sec.	9 min. 2 sec.	16 min. 12 sec.	6 hr. 17 min. 45 sec.
 320x240	★★★	23 sec.	9 min. 2 sec.	46 sec.	18 min. 4 sec.		

The recording time is for reference only. The actual recording time may vary depending on the SD Memory Card and the subject.

White Balance	Auto, Daylight, Shade, Tungsten Light, Fluorescent Light, Manual	
Lens	Focal Length	6.2 mm - 18.6 mm (equivalent to 37.5 mm - 112.5 mm in 35 mm format)
	Aperture	f/2.8 - f/5.2
	Lens Composition	6 elements in 5 groups (3 dual-sided aspherical elements)
	Zoom Type	Electrically driven
	Picture Range	Approx. 157 mm x 118 mm (Macro mode)
	Lens Cover	Electrically driven
Digital Zoom	Capture Mode	Max. x4 (combines with x3 optical zoom to give zoom magnification equivalent to x12)
LCD Monitor	2.4-inch TFT color LCD monitor (with backlight), brightness adjustable in two steps (Economy, Normal), approx. 110,000 pixels	
Playback Functions	Single-frame, 9-frame index, enlargement (max. x8, scroll), folder display, calendar display, rotating, sound playback, voice memo playback, slideshow, movie playback, histogram display, Select & Delete, image/sound copying, digital filter (B&W, Sepia, Red, Pink, Purple, Blue, Green, Yellow, Tile, Soft), brightness filter, cropping, resizing, frame composite, red-eye compensation, protect, DPOF	

Focus Modes	Autofocus, Macro, Infinity, Pan Focus, Manual Focus	
	AF type	TTL contrast detection system by sensor (multiple/spot/continuous changeable) with auxiliary AF light
	Focus Range (from lens front)	Normal : Approx. 0.4 m - ∞ (whole zoom area) Macro : Approx. 0.15 m - 0.5 m (Wide) Infinity : ∞ (whole zoom area) Pan focus : Approx. 1.5 m - ∞ (Wide), approx. 5.9 m - ∞ (Tele) Manual focus: Approx. 0.15 m - ∞ (Wide), approx. 0.4 m - ∞ (Tele) * Face Recognition AF is available only in [Auto Picture], [Program], [Portrait] and [Kids].
	Focus Lock	By half-pressing shutter release button
Exposure Mechanism	AE metering	TTL metering by sensor (multi-segment metering)
	EV Compensation	±2 EV (can be set in 1/3 EV steps)
Capture Modes	Green, Auto Picture, Program, Night Scene, Movie, Voice Recording, Landscape, Flower, Portrait, Surf & Snow, Sport, Digital SR, Kids, Pet, Digital Panorama, Frame Composite	
Movie	Continuous Recording Time	Approx. 1 second - until built-in memory or SD Memory Card is full (There is a limitation of max. 2GB regardless of SD memory card capacity.)
Digital Filter	B&W, Sepia, Red, Pink, Purple, Blue, Green, Yellow, Tile, Soft	
Shutter	Type	Electronic/mechanical shutter
	Speed	Approx. 1/2000 sec. - 4 sec.
Flash	Type	Auto flash with red-eye reduction function
	Flash Modes	Auto (at low illumination), Flash Off, Flash On, Auto + Red-eye, Flash On + Red-eye (Slow synchronization is possible only in Night Scene mode)
	Effective Range	Wide: Approx. 0.15 m to 4.3 m (in ISO Auto), approx. 0.15 m to 6.8 m (in Digital SR mode) Tele : Approx. 0.5 m to 2.3 m (in ISO Auto), approx. 0.4 m to 3.6 m (in Digital SR mode)
Drive Modes	Single-frame, Self-timer (approx. 10 sec., approx. 2 sec.), Continuous Shooting, 16-frame shooting	
Power Supply	Two AA (alkaline, lithium, nickel manganese or Ni-MH) batteries, AC adapter kit (optional)	

Battery Life (When using AA alkaline batteries)	Number of Recordable Images 240 pictures	* Recording capacity shows approximate number of shots recorded during CIPA- compliant testing (with LCD monitor on, flash used for 50% of the shots, and 23 °C). Actual performance may vary according to operating conditions.
	Playback Time 400 min.	
	Movie Recording Time 90 min.	* The playback time/recording time are measured based on in-house testing. Actual time may differ depending on the condition of use.
	Sound Recording Time 290 min.	
In/Out Port	USB/AV terminal, Dock terminal	
Video Output Format	NTSC/PAL (monaural)	
PictBridge	Printer	PictBridge-compatible printer
	Print Modes	Print One, Print All, DPOF AUTOPRINT
	Paper Size	Card, L, 2L, Postcard, 100 mm×150 mm, 4"×6", 8"×10", Letter, 11"×17", A4, A3, printer setting
	Paper Type	★★★, ★★, ★, printer setting
	Quality	★★★, ★★, ★, printer setting
	Border Status	With/without, printer setting
ImageLink	Kodak ImageLink system supported	
Size	94 (W) × 60 (H) × 24 (D) mm (excluding operating or protruding parts)	
Weight	130 g (excluding the batteries and SD Memory Card)	
Weight When Shooting	175 g (including the batteries and SD Memory Card)	
Accessories	Two AA alkaline batteries, USB/AV cable, Software (CD-ROM), Strap, Dock insert, Operating Manual/PC Connection Manual (CD- ROM), Quick Guide	



# WARRANTY POLICY

All PENTAX cameras purchased through authorized bona fide photographic distribution channels are guaranteed against defects of material or workmanship for a period of twelve months from date of purchase. Service will be rendered, and defective parts will be replaced without cost to you within that period, provided the equipment does not show evidence of impact, sand or liquid damage, mishandling, tampering, battery or chemical corrosion, operation contrary to operating instructions, or modification by an unauthorized repair shop. The manufacturer or its authorized representatives shall not be liable for any repair or alterations except those made with its written consent and shall not be liable for damages from delay or loss of use or from other indirect or consequential damages of any kind, whether caused by defective material or workmanship or otherwise; and it is expressly agreed that the liability of the manufacturer or its representatives under all guarantees or warranties, whether expressed or implied, is strictly limited to the replacement of parts as hereinbefore provided. No refunds will be made on repairs by non-authorized PENTAX service facilities.

## Procedure During 12-month Warranty Period

Any PENTAX which proves defective during the 12-month warranty period should be returned to the dealer from whom you purchased the equipment or to the manufacturer. If there is no representative of the manufacturer in your country, send the equipment to the manufacturer, with postage prepaid. In this case, it will take a considerable length of time before the equipment can be returned to you owing to the complicated customs procedures required. If the equipment is covered by warranty, repairs will be made and parts replaced free of charge, and the equipment will be returned to you upon completion of servicing. If the equipment is not covered by warranty, regular charges of the manufacturer or of its representatives will apply. Shipping charges are to be borne by the owner. If your PENTAX was purchased outside of the country where you wish to have it serviced during the warranty period, regular handling and servicing fees may be charged by the manufacturer's representatives in that country. Notwithstanding this, your PENTAX returned to the manufacturer will be serviced free of charge according to this procedure and warranty policy. In any case, however, shipping charges and customs clearance fees to be borne by the sender. To prove the date of your purchase when required, please keep the receipt or bills covering the purchase of your equipment for at least a year. Before sending your equipment for servicing, please make sure that you are sending it to the manufacturer's authorized representatives or their approved repair shops, unless you are sending it directly to the manufacturer. Always obtain a quotation for the service charge, and only after you accept the quoted service charge, instruct the service station to proceed with the servicing.

- This warranty policy does not affect the customer's statutory rights.
- The local warranty policies available from PENTAX distributors in some countries can supersede this warranty policy. Therefore, we recommend that you review the warranty card supplied with your product at the time of purchase, or contact the PENTAX distributor in your country for more information and to receive a copy of the warranty policy.



The CE Mark is a Directive conformity mark of the European Union.

## **For customers in USA**

### **STATEMENT OF FCC COMPLIANCE**

This device complies with Part 15 of the FCC Rules. Operation is subject to the following two conditions: (1) This device may not cause harmful interference, and (2) this device must accept any interference received, including interference that may cause undesired operation.

Changes or modifications not approved by the party responsible for compliance could void the user's authority to operate the equipment. This equipment has been tested and found to comply with the limits for a Class B digital device, pursuant to part 15 of the FCC Rules. These limits are designed to provide reasonable protection against harmful interference in a residential installation. This equipment generates, uses and can radiate frequency energy and, if not installed and used in accordance with the instructions, may cause harmful interference to radio communications. However, there is no guarantee that interference will not occur in a particular installation.

If this equipment does cause harmful interference to radio or television reception, which can be determined by turning the equipment off and on, the user is encouraged to try to correct the interference by one or more of the following measures:

- Reorient or relocate the receiving antenna.
  - Increase the separation between the equipment and receiver.
  - Connect the equipment into an outlet on a circuit different from that to which the receiver is connected.
- \* Consult the dealer or an experienced radio/TV technician for help.

## **For customers in Canada**

This Class B digital apparatus complies with Canadian ICES-003.

## **Pour les utilisateurs au Canada**

Cet appareil numérique de la classe B est conforme à la norme NMB-003 du Canada.

# Declaration of Conformity

According to 47CFR, Parts 2 and 15 for  
Class B Personal Computers and Peripherals

We: PENTAX Imaging Company  
A Division of PENTAX of America, Inc.

Located at: 600 12<sup>th</sup> Street, Suite 300  
Golden, Colorado 80401 U.S.A.  
Phone: 303-799-8000 FAX: 303-790-1131

Declare under sole responsibility that the product identified herein complies with 47CFR Parts 2 and 15 of the FCC rules as a Class B digital device. Each product marketed is identical to the representative unit tested and found to be compliant with the standards. Records maintained continue to reflect the equipment being produced can be expected to be within the variation accepted, due to quantity production and testing on the statistical basis as required by 47CFR §2.909. Operation is subject to the following two conditions: (1) This device may not cause harmful interference, and (2) This device must accept any interference received, including interference that may cause undesired operation. The above named party is responsible for ensuring that the equipment complies with the standards of 47CFR §15.101 to §15.109.

Product Name: PENTAX Digital Still Camera

Model Number: Optio E40

Contact person: Customer Service Manager

Date and Place: August, 2007, Colorado

## Information on disposal for users



### 1. In the European Union

If your product is marked with this symbol, it means that used electrical/electronic products should not be mixed with general household waste. There exists a separate collection system for these products.

Used electric/electronic equipment must be treated separately and in accordance with legislation that requires proper treatment, recovery and recycling of these products. Following the implementation by member states, private households within the EU states may return their used electrical/electronic equipment to designated collection facilities free of charge\*. In some countries your local retailer may also take back your old product free of charge if you purchase a similar new one.

\*Please contact your local authority for further details.

By disposing of this product correctly you will help ensure that the waste undergoes the necessary treatment, recovery and recycling and thus prevent potential negative effects on the environment and human health which could otherwise arise due to inappropriate waste handling.

### 2. In other countries outside the EU

If you wish to discard this product, please contact your local authorities and ask for the correct method of disposal.

For Switzerland: Used electrical/electronic equipment can be returned free of charge to the dealer, even when you don't purchase a new product. Further collection facilities are listed on the home page of [www.swico.ch](http://www.swico.ch) or [www.sens.ch](http://www.sens.ch).

## Symbols

[ Rec. Mode] menu .....	43
mode (Capture mode)	31, 36
button .....	36, 38
mode (Playback mode)	33, 38
[ Setting] menu .....	44
Green Mode .....	48
Green Button .....	37, 39
Delete .....	35, 100
Tele .....	65
Wide .....	65
Magnify .....	95
Nine-image display .....	93
Self-timer .....	80
Auto Picture .....	50
Program .....	51
Night Scene .....	55
Movie .....	87
Voice Recording .....	126
Landscape .....	46
Flower .....	46
Portrait .....	52
Surf & Snow .....	46
Sport .....	46
Digital SR .....	56
Kids .....	52
Pet .....	54
Digital Panorama .....	59
Frame Composite .....	57

## Numerics

16-frame shooting  .....	81
--------------------------	----

## A

AC adapter .....	20
------------------	----

## Adding sound

(Voice Memo) .....	129
AF Mode .....	70
Auto  .....	71
Auto <b>AWB</b> .....	74
Auto Power Off .....	142
AV equipment .....	99

## B













Basic mode .....	48
Batteries .....	18
Battery level indicator  ...	19
Brightness Filter .....	113
Brightness level .....	140



## C

Calendar display .....	94
Camera shake .....	56, 65, 78
Capture Mode Palette .....	45
Changing volume .....	128, 132
Checking the memory	
card .....	26
Color Mode .....	91
Computer .....	138
Connecting to a printer .....	120
Continuous Shooting  ...	81
Contrast .....	77
Copy .....	110
Cropping .....	109



## D

Date and time .....	29, 134
Date Imprint .....	83
Daylight  .....	74
Default setting .....	28
Delete  .....	100
Deleting sounds .....	101
Digital Filter .....	112

Digital Panorama 	59	Macro 	67
Digital SR 	56	Magnify 	95
Digital Zoom	66	Manual Focus <b>MF</b>	67
Dock insert	125	Manual 	74
DPOF printing	124	Memory	85
DPOF settings	117		
<b>F</b>		<b>N</b>	
Face Recognition AF&AE	46	Nine-image display 	93
File No.	85	NTSC	139
Flash	71	<b>O</b>	
Flash Off 	71	<b>OK/DISPLAY</b> button	37, 39
Flash On 	71	Optional accessory	150
Fluorescent Light 	74	<b>P</b>	
Focus lock	69	PAL	139
Focus Mode	67	Pan Focus <b>PF</b>	67
Folder display	94	Photo processing lab	117
Folder Name	137	PictBridge	120
Format	131	Playback	33, 92, 98, 128, 130
Four-way controller	37, 39	Playback Mode Palette	47
Frame Composite	114	Playing back movies	98
Frame Rate	90	Playing back sounds	128
<b>G</b>		Power Saving	141
Green Button 	37, 39	Power supply	18, 26
Green Mode 	48	Power switch	26, 36, 38
Guide Display	46, 47, 143	Press fully (Shutter release button)	32
<b>H</b>		Press halfway (Shutter release button)	32
Histogram	79	Printing	120
<b>I</b>		Protect 	105
ImageLink	125	<b>Q</b>	
Infinity 	67	Quality Level	25, 63
Installing batteries	18	<b>R</b>	
Instant Review	84	Recorded Pixels of movies	89
<b>L</b>		Recorded Pixels of still pictures	61
Language	28, 136		
<b>M</b>			
<b>MENU</b> button	37, 39		

Recording movies .....	87
Recording sounds .....	126
Red-eye Compensation ....	116
Red-eye reduction  	71
Reset .....	144
Resize .....	107
Rotating .....	34

## S

Saturation .....	77
Saving settings .....	85
SD Memory Card .....	22
Self-timer 	80
Sensitivity .....	73
Setting the exposure .....	76
Shade 	74
Sharpness .....	77
Shooting information ....	78, 92
Shutter release button .....	32, 36, 38
Slideshow .....	96
Sound settings .....	132
Sound types .....	132
Standard <b>AF</b> .....	67
Start-up screen .....	145
Storage Capacity .....	155
Strap .....	17

## T

Tungsten Light 	74
TV .....	99

## U

USB connection mode ....	138
--------------------------	-----





## V

Video output format .....	139
Voice Memo .....	129

## W

White Balance .....	74
---------------------	----

## Z

Zoom    	65
Zoom button .....	36, 38



<b>PENTAX Corporation</b>	2-36-9, Maeno-cho, Itabashi-ku, Tokyo 174-8639, JAPAN ( <a href="http://www.pentax.co.jp/">http://www.pentax.co.jp/</a> )
<b>PENTAX Europe GmbH (European Headquarters)</b>	Julius-Vosseler-Strasse 104, 22527 Hamburg, GERMANY (HQ - <a href="http://www.pentaxeuropa.com">http://www.pentaxeuropa.com</a> ) (Germany - <a href="http://www.pentax.de">http://www.pentax.de</a> )
<b>PENTAX U.K. Limited</b>	PENTAX House, Heron Drive, Langley, Slough, Berks SL3 8PN, U.K. ( <a href="http://www.pentax.co.uk">http://www.pentax.co.uk</a> )
<b>PENTAX France S.A.S.</b>	112 Quai de Bezons, B.P. 204, 95106 Argenteuil Cedex, FRANCE ( <a href="http://www.pentax.fr">http://www.pentax.fr</a> )
<b>PENTAX Italia S.r.l.</b>	Via Dione Cassio 15, 20138 Milano, ITALY ( <a href="http://www.pentaxitalia.it">http://www.pentaxitalia.it</a> )
<b>PENTAX (Schweiz) AG</b>	Widenholzstrasse 1, 8304 Wallisellen, Postfach 367, 8305 Dietlikon, SWITZERLAND ( <a href="http://www.pentax.ch">http://www.pentax.ch</a> )
<b>PENTAX Scandinavia AB</b>	P.O. Box 650, 75127 Uppsala, SWEDEN ( <a href="http://www.pentax.se">http://www.pentax.se</a> )
<b>PENTAX Imaging Company A Division of PENTAX of America, Inc.</b>	(Headquarters) 600 12th Street, Suite 300 Golden, Colorado 80401, U.S.A. (PENTAX Service Department) 12000 Zuni Street, Suite 100B Westminster, Colorado 80234, U.S.A. ( <a href="http://www.pentaximaging.com">http://www.pentaximaging.com</a> )
<b>PENTAX Canada Inc.</b>	1770 Argentia Road Mississauga, Ontario L5N 3S7, CANADA ( <a href="http://www.pentax.ca">http://www.pentax.ca</a> )



for your  
precious moments

<http://www.pentax.co.jp/english>

- Specifications and external dimensions are subject to change without notice.